



Version 1.0



ZANITA

OCCASIONAL SET

www.fantasticfurniture.com.au

Recommended weight capacity : 20kgs/table.

Enjoy

Your purchase from
Australia's Best Value Furniture Store



Assembly checklist



Read through the instructions carefully before you begin.

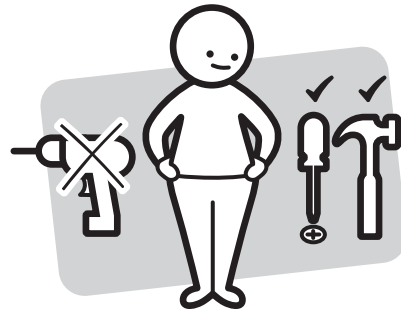

Make sure you have all the required tools. Never use power tools unless instructed.

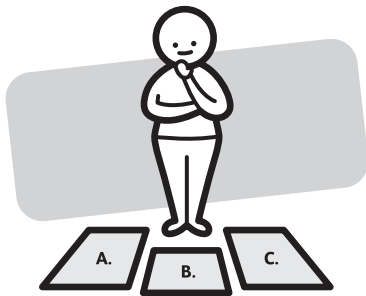

Identify and lay out all of the components before you begin assembly.

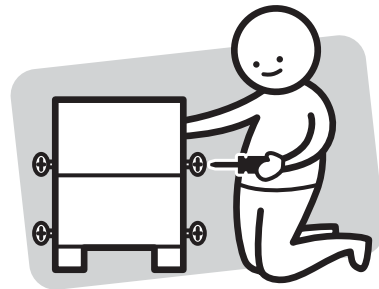

Unless instructed, do not fully tighten screws until the item is fully assembled.

Useful Information

- ! Never use power tools unless specifically instructed. They can damage your components or hardware if used incorrectly.
- ! The most common mistakes made during assembly are using the wrong hardware or getting components back to front.
- ! Always use a soft surface (such as carpet or cardboard) when assembling your product to avoid scratching or damaging the surface of the product.
- ! Bulky items such as wardrobes and bunk beds should be assembled in the room they will be used in as they may not fit through a door once assembled.
- ! Never use any glue until you are certain that the parts belong together.
- ! Periodically check and re-tighten all fasteners. Check the product care label or website for product care instructions.
- ! If you are having any difficulties assembling your product, missing any hardware or components please visit our website Help Centre for further assistance.
- ! Please see page 2 for any safety requirements or weight restrictions.

What you need to assemble the product



DO NOT USE

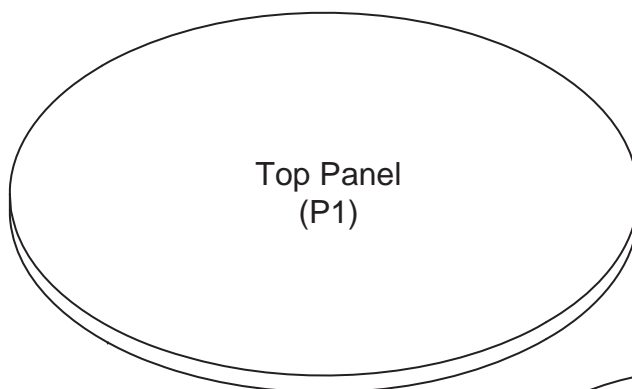

Top Panel
(P1)

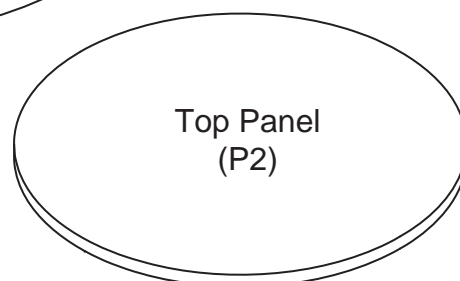

Top Panel
(P2)

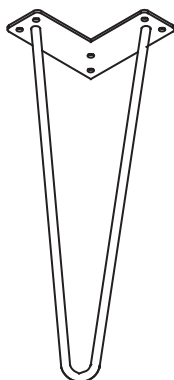

3 x Legs
(P3)

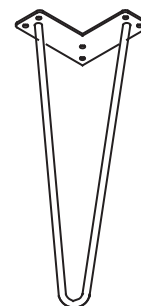

3 x Legs
(P4)

Parts list

Box 1:

Top panel (P1);

Top panel (P2);



3 x Legs (P3);

3 x Legs (P4);

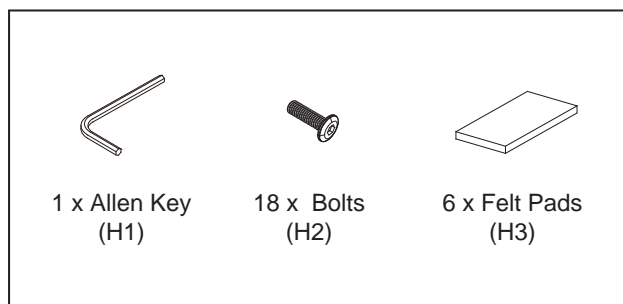
Hardware Pack



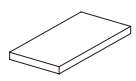

Step 1

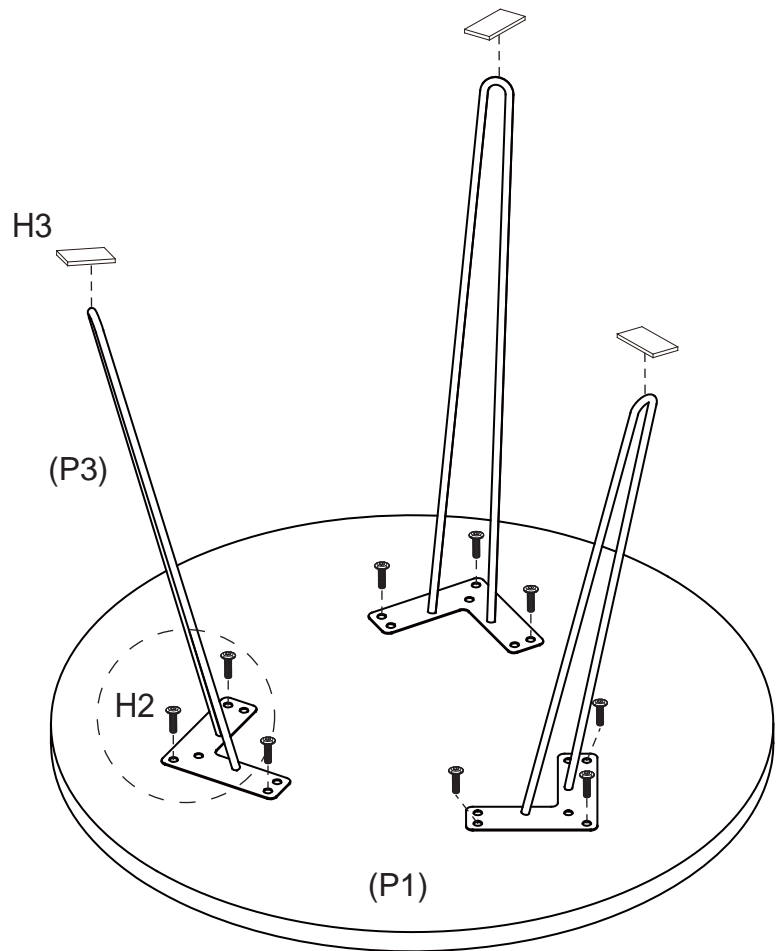
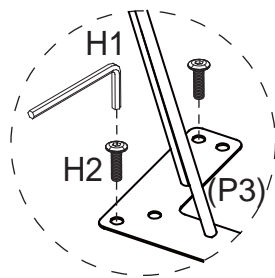
You will need	
	
1 x Allen Key (H1)	9 x Bolts (H2)
	
3 x Felt Pads (H3)	



Attach 3x legs (P3) to Top panel (P1) and secure with 9 x bolts (H2). Tighten with an Allen key (H1). Apply 3x felt pads (H3) to bottom of legs (P3) as shown.

Step 2

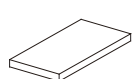
You will need	
	
1 x Allen Key (H1)	9 x Bolts (H2)
	
3 x Felt Pads (H3)	

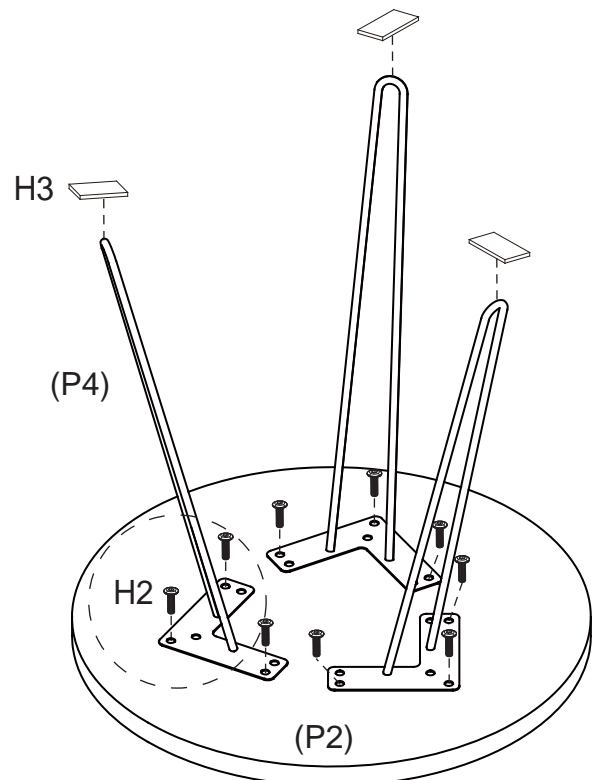
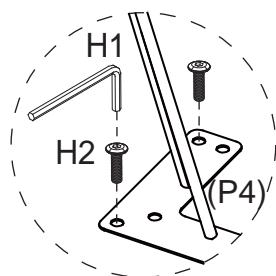

Attach 3x legs (P4) to Top panel (P2) and secure with 9 x bolts (H2). Tighten with an Allen key (H1). Apply 3x felt pads (H3) to bottom of legs (P4) as shown.

Step 3



Job Complete!

In the interest of our environment please dispose of all packaging thoughtfully.