

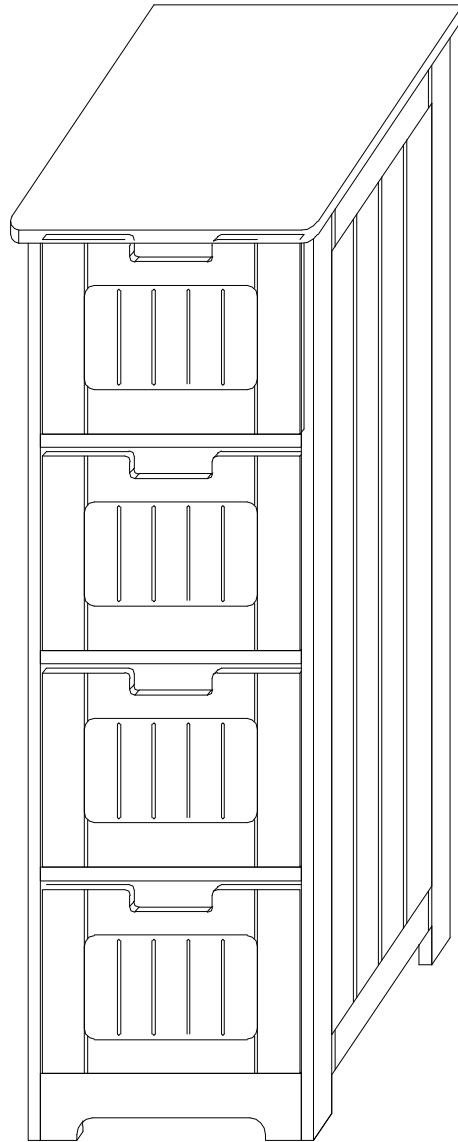

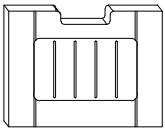

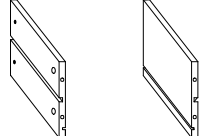



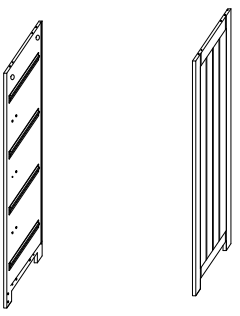
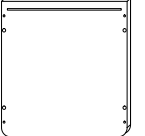

MODEL:ST-CAB-B-4DKD-WH

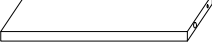
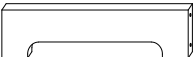
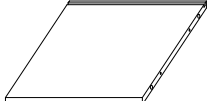

 <b>Ax4</b>	 <b>B1x4 B2x4</b>	 <b>Cx4</b>	 <b>Dx4</b>	 <b>E1x1 E2x1</b>
 <b>Fx1</b>	 <b>Gx1</b>	 <b>Hx2</b>	 <b>Ix1</b>	
 <b>Jx1</b>	 <b>Kx1</b>	 <b>ax26</b>	 <b>bx26</b>	 <b>cx22</b>
 <b>dx16</b>	 <b>ex4</b>	 <b>fx4</b>		

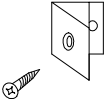
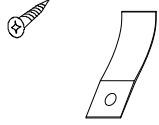
Step 1

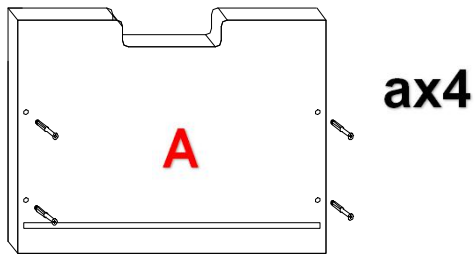

Step 2

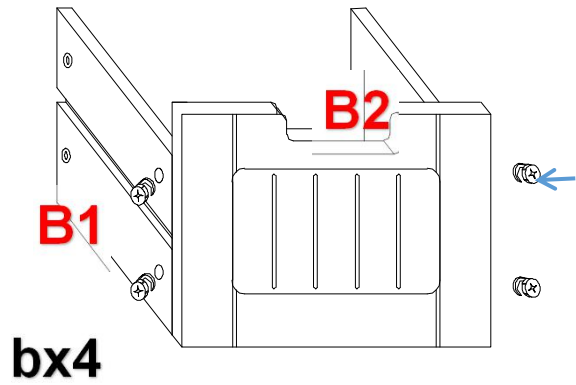

Step 3

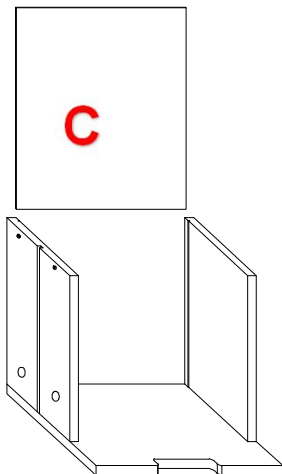

Step 4

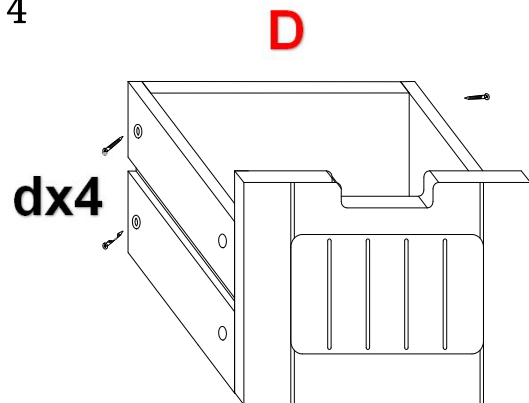

Step 5

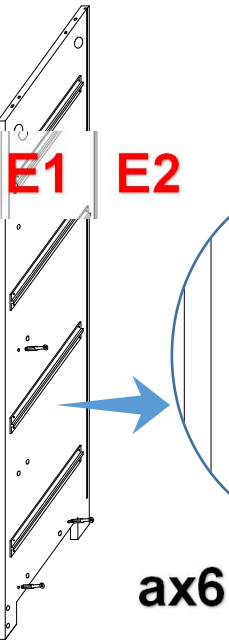

Step 6

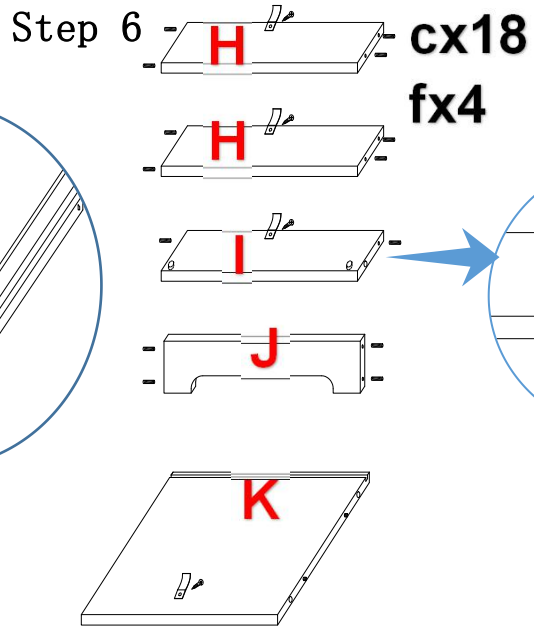

Step 7

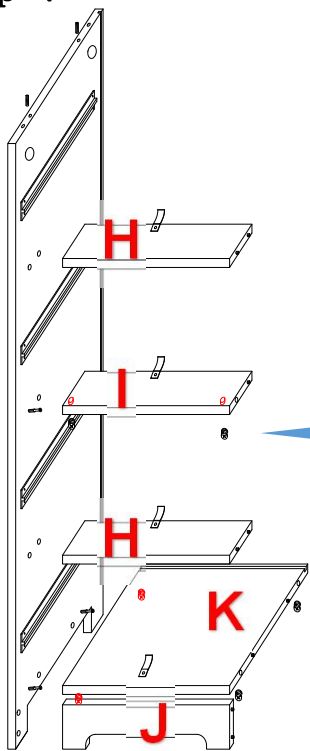

Step 8

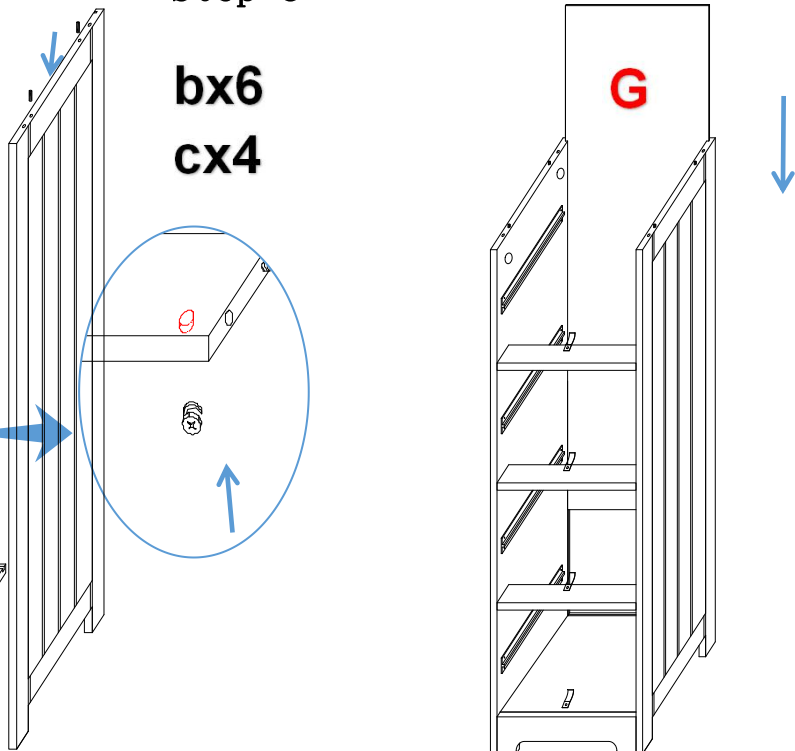

Step 9

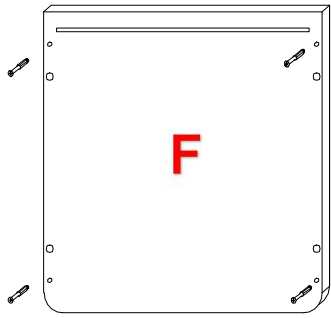

**ax4**

Step 10

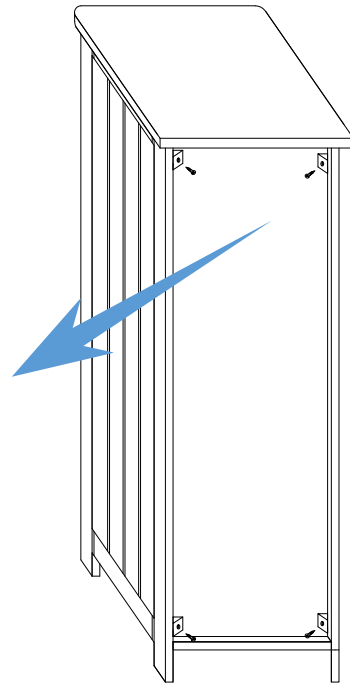
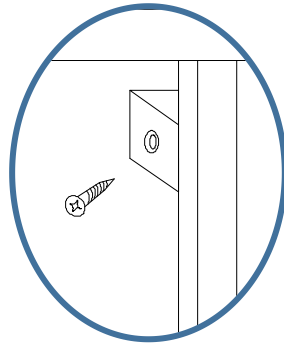

**ex4**

Step 11

**bx4**

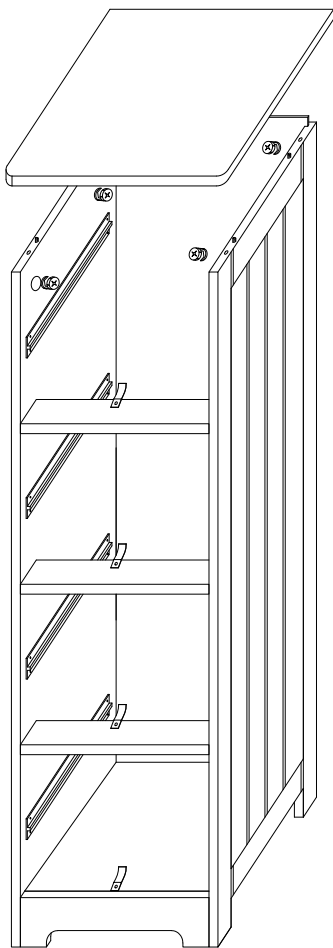

Step 12

