

Assembly Instructions

WILLOW BED SINGLE



WHAT YOU NEED

To assemble the Body



Allen Key provided

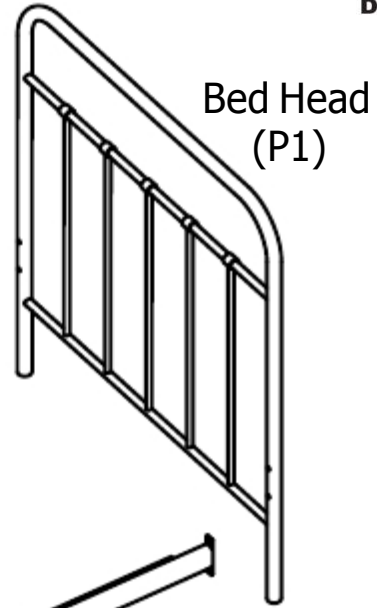

Bed Head
(P1)

2 x Side Rails
(P3)

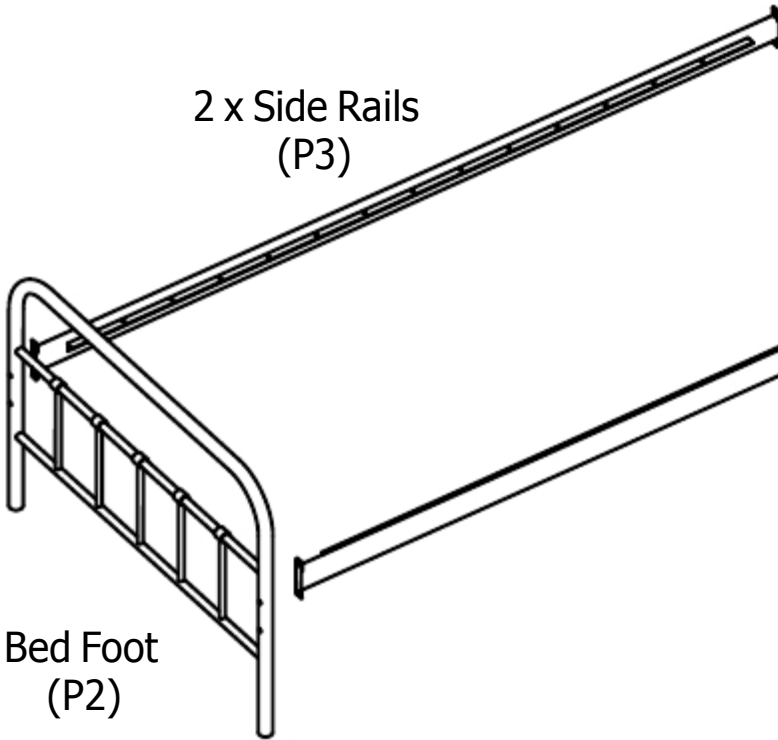

Bed Foot
(P2)

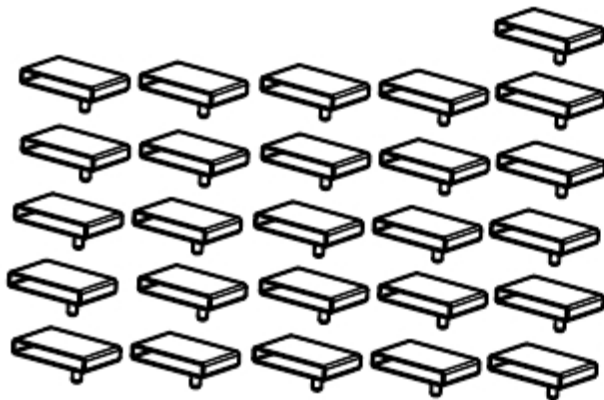

26 x Plastic Connectors
(P4)

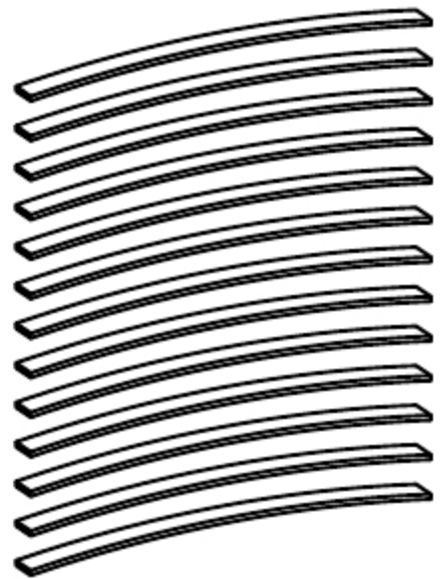

13 x Fantastic Furniture
ComfortSlats™ Single (P5)



8 x Bolts
(H1)

Please make sure you have all these parts before you start.

Step 1

You will need	
2 x Bolts (H1)	

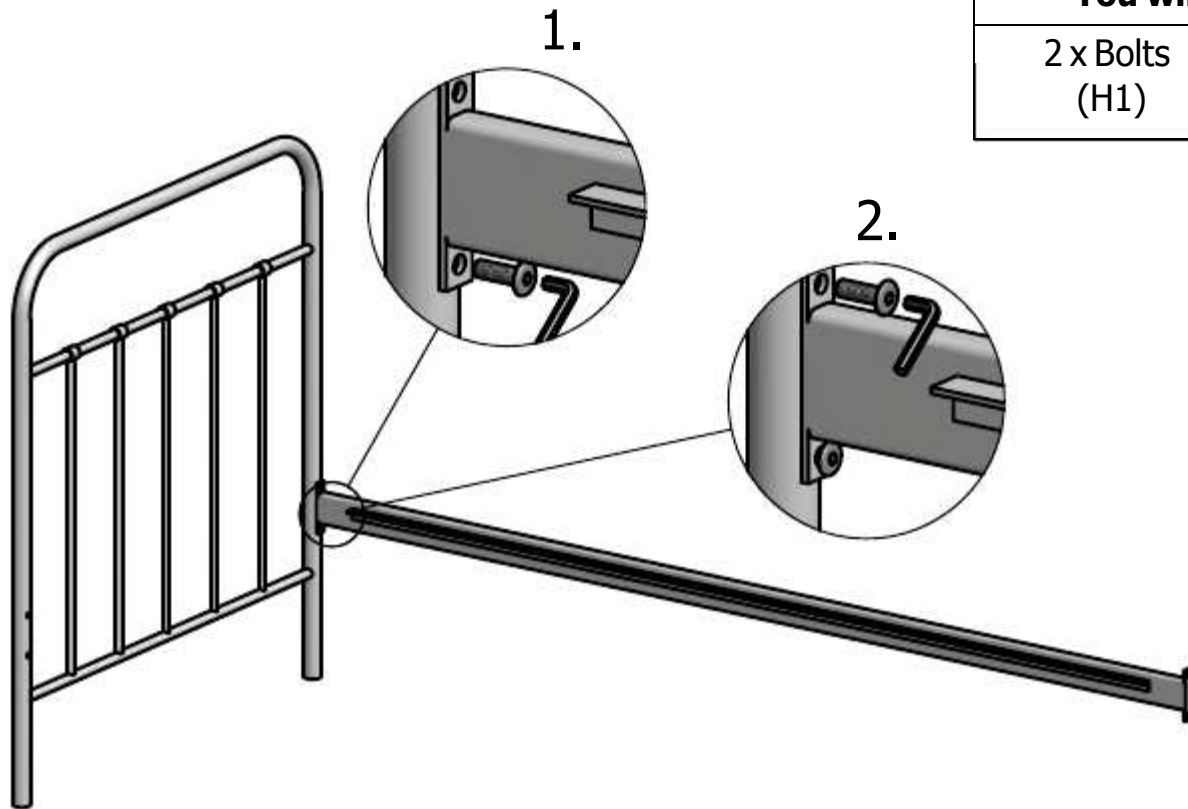

Attach one Side Rail (P3) to the Bed Head (P1) with Bolts (H1). Do not fully tighten Bolts

Step 2

You will need	
2 x Bolts (H1)	

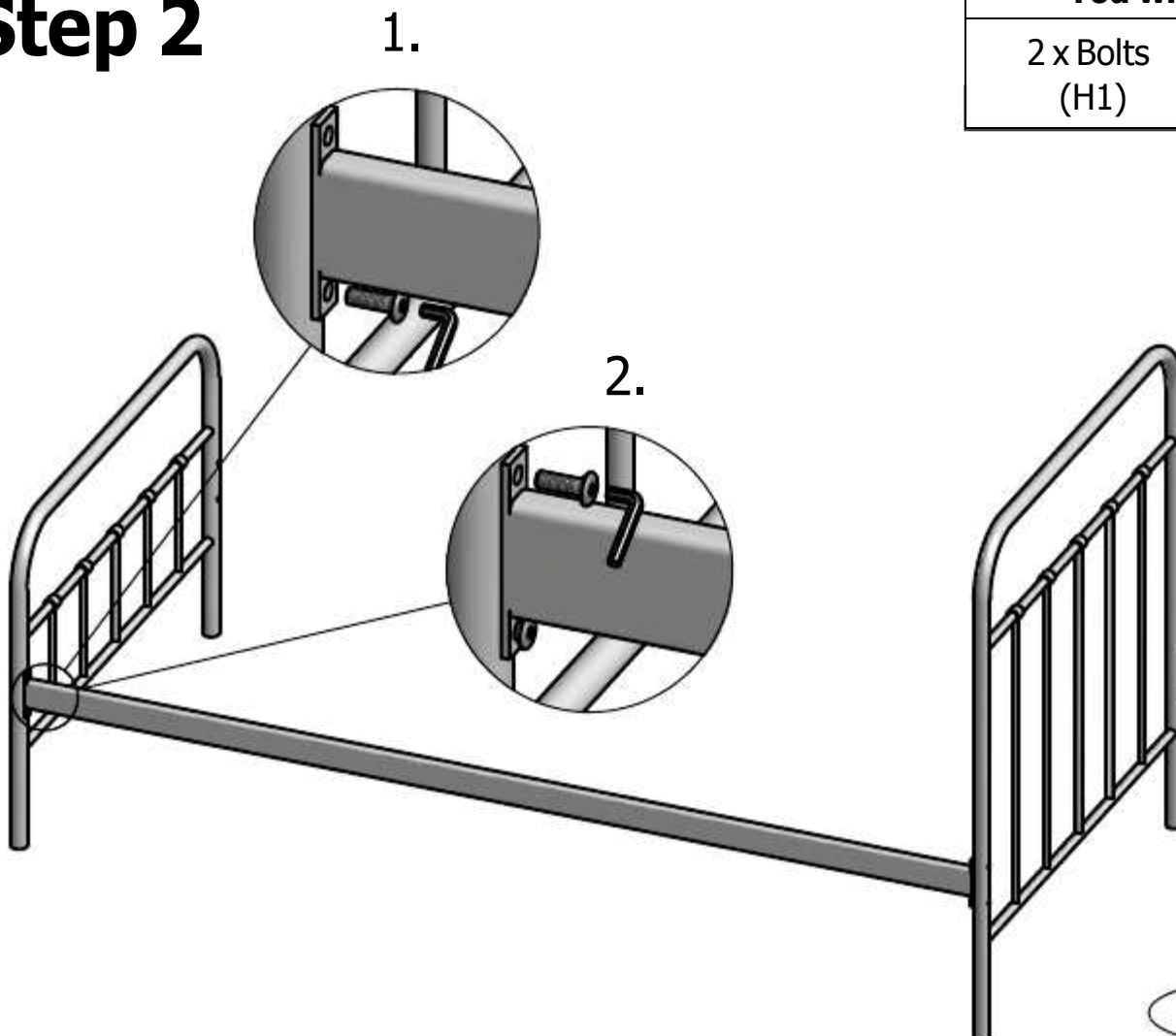

Attach one Side Rail (P3) to the Bed Foot (P2) with Bolts (H1). Leave bolt loose.

Step 3

You will need	
4 x Bolts (H1)	

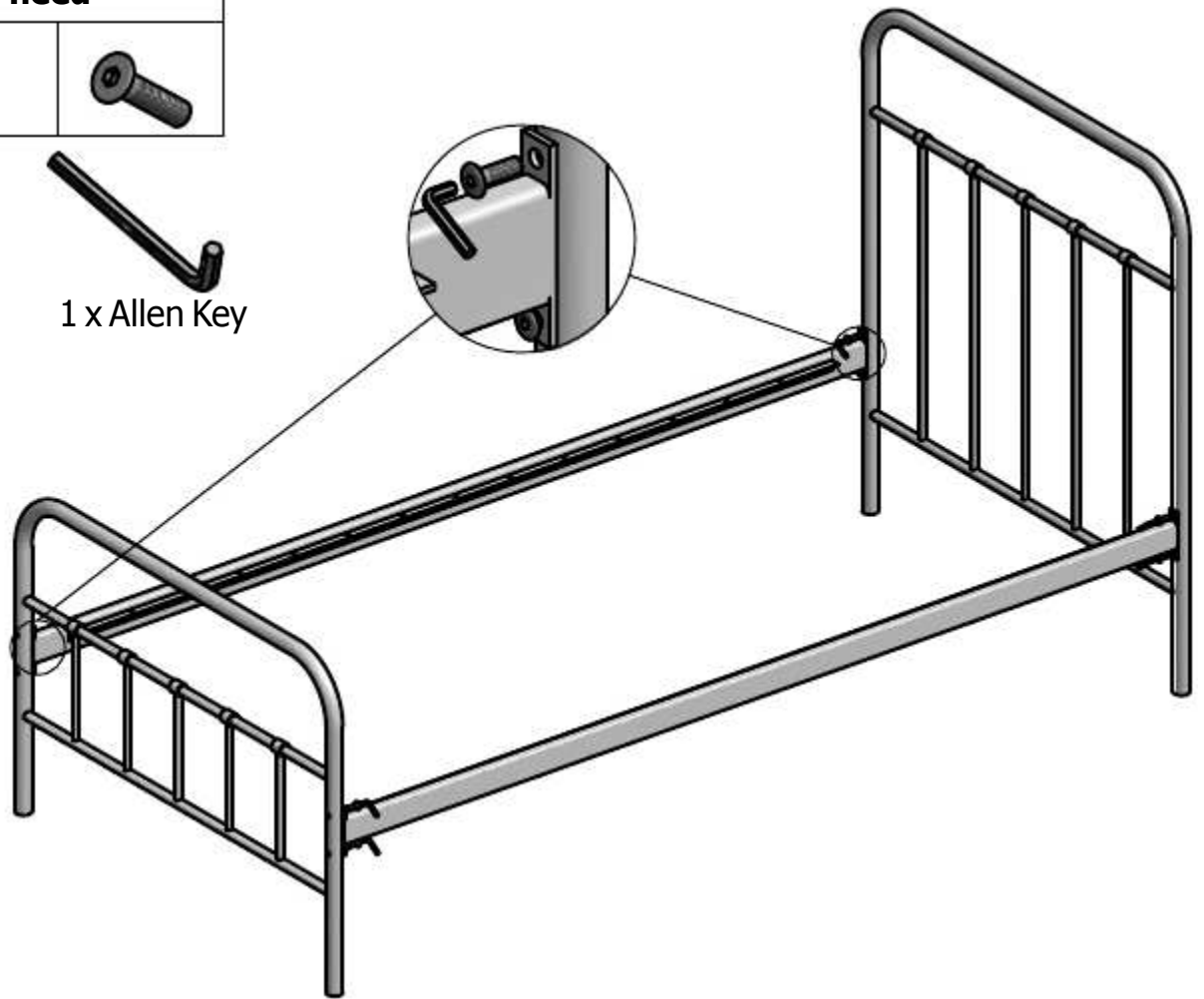

Attach the other Side Rail (P3) to the Bed Head and Bed Foot with 4 x Bolts (H1) in the upper holes. Leave bolts loose

Step 4

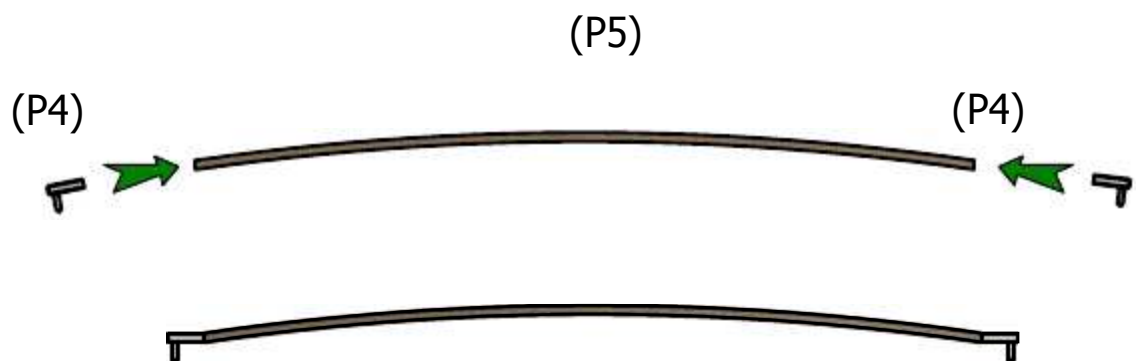

YOU WILL NEED	
26 X Plastic Connectors (P4)	
13 x Fantastic Furniture ComfortSlats™ Single (P5)	

Push 26 x Plastic Connectors (P4) firmly onto 13 x Fantastic Furniture™ ComfortSlats Single (P5)

Step 5a

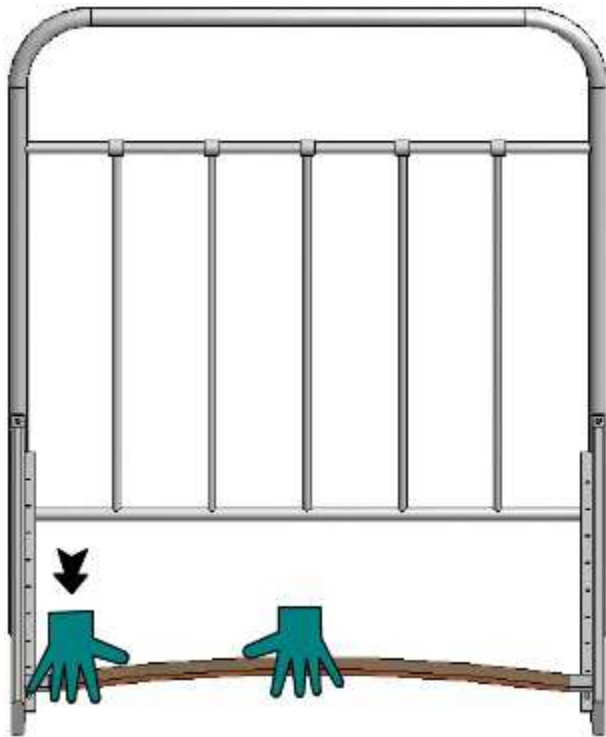

Place the slat in position then push down on the centre of the slat to flatten out the slat. Make sure the plastic prong lines up with the hole. Then push firmly

Step 5b

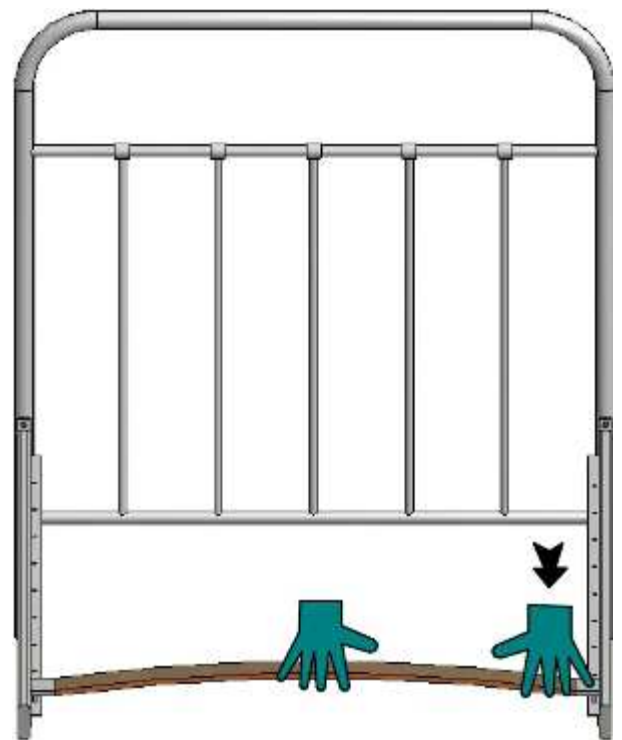

Repeat the same process for the other end of the slat

Step 6

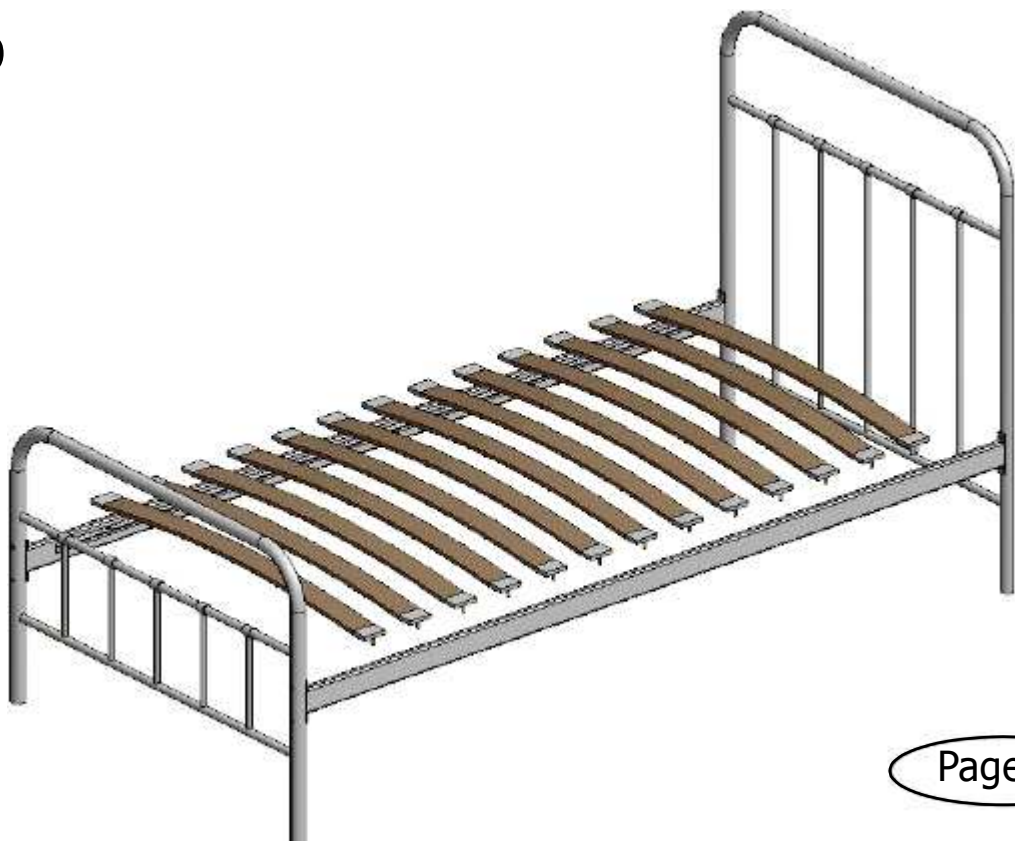

Repeat for every bed slat until finished

Step 6

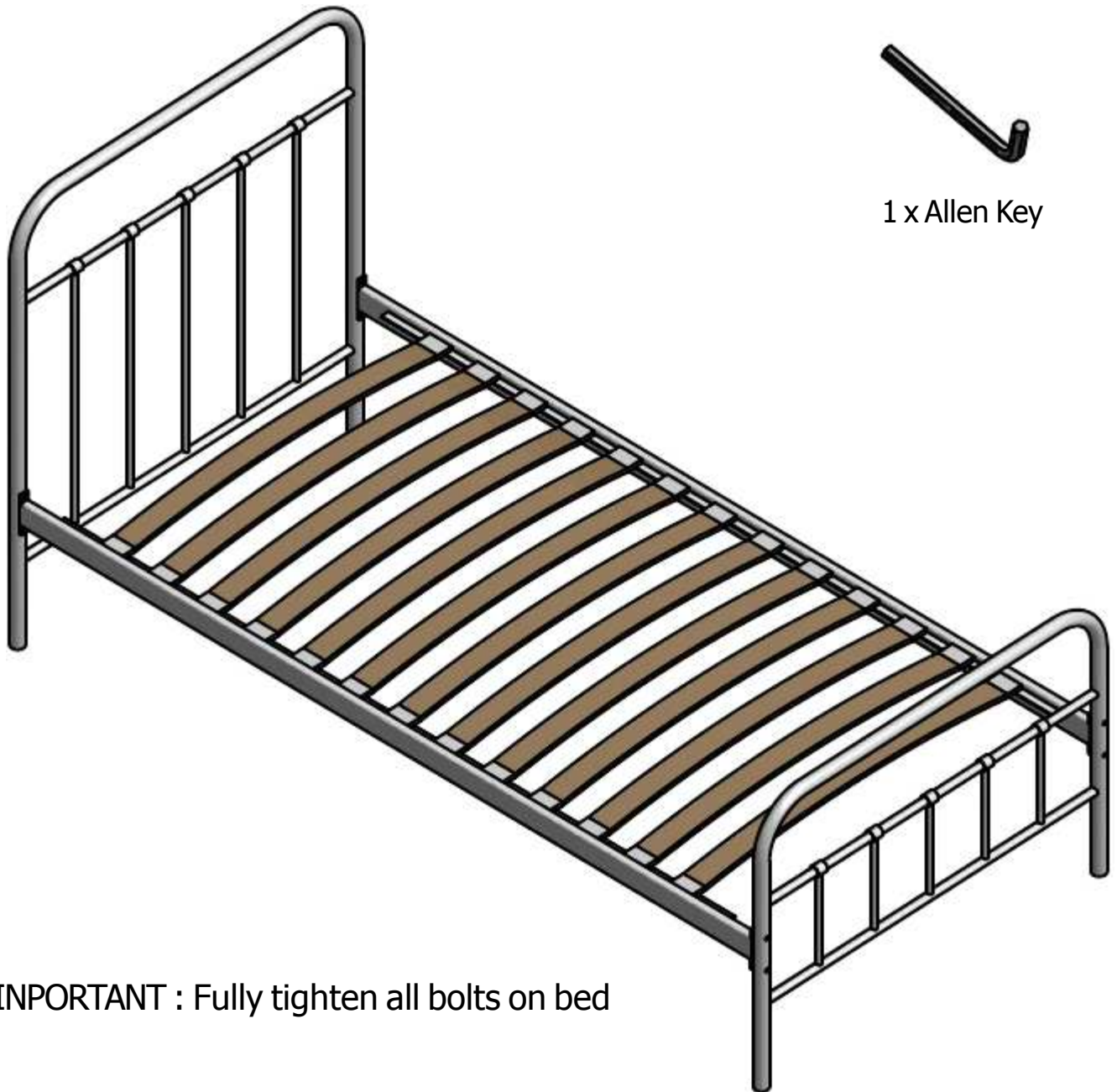

IMPORTANT : Fully tighten all bolts on bed

The job is now complete !

In the interest of our environment
Please dispose of all packaging thoughtfully.