

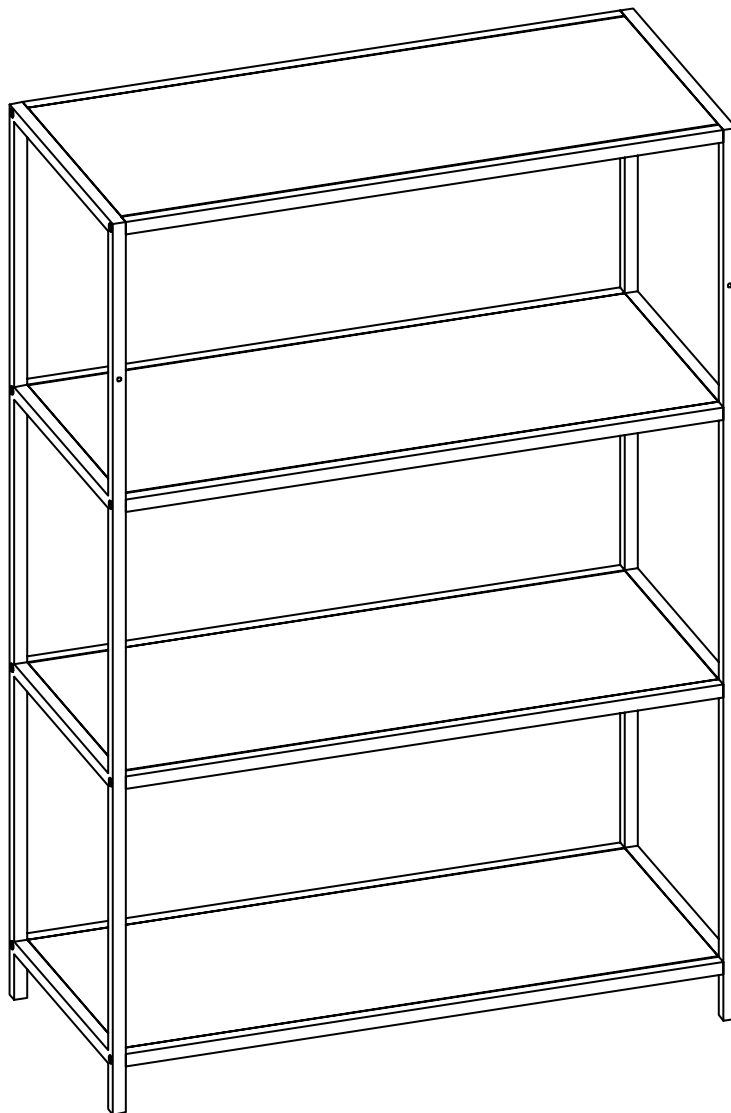

Version 2.0



TWO PEOPLE



REQUIRED

Seaforth

Bookcase 4 shelf

www.fantasticfurniture.com.au

RECOMMENDED WEIGHT CAPACITY 15 KG



**WARNING: ENSURE THE WALL STRAP IS ATTACHED TO
AVOID SERIOUS INJURY.**

To avoid any serious or fatal injury, this product has been fitted with a wall strap to prevent toppling. We strongly recommend that this product is permanently fixed to the wall or other suitable surface. Fixing devices are not included since different surface materials require different attachments. Please seek professional advice if you are in doubt of what fixing device to use.

Enjoy

Your purchase from
Australia's Best Value Furniture Store



Assembly checklist



Read through the instructions carefully before you begin.



Make sure you have all the required tools. Never use power tools unless instructed.



Identify and lay out all of the components before you begin assembly.

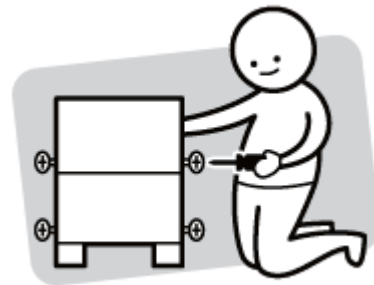

Unless instructed, do not fully tighten screws until the item is fully assembled.

Useful Information

- ! Never use power tools unless specifically instructed. They can damage your components or hardware if used incorrectly
- ! The most common mistakes made during assembly are using the wrong hardware or getting components back to front.
- ! Always use a soft surface (such as carpet or cardboard) when assembling your product to avoid scratching or damaging the surface of the product.
- ! Bulky items such as wardrobes and bunk beds should be assembled in the room they will be used in as they may not fit through a door once assembled.
- ! Never use any glue until you are certain that the parts belong together.
- ! Periodically check and re-tighten all fasteners. Check the product care label or website for product care instructions.
- ! If you are having any difficulties assembling your product, missing any hardware or components please visit our website Help Centre for further assistance.
- ! Please see page 2 for any safety requirements or weight restrictions.

What you need

to assemble the product



DO NOT USE







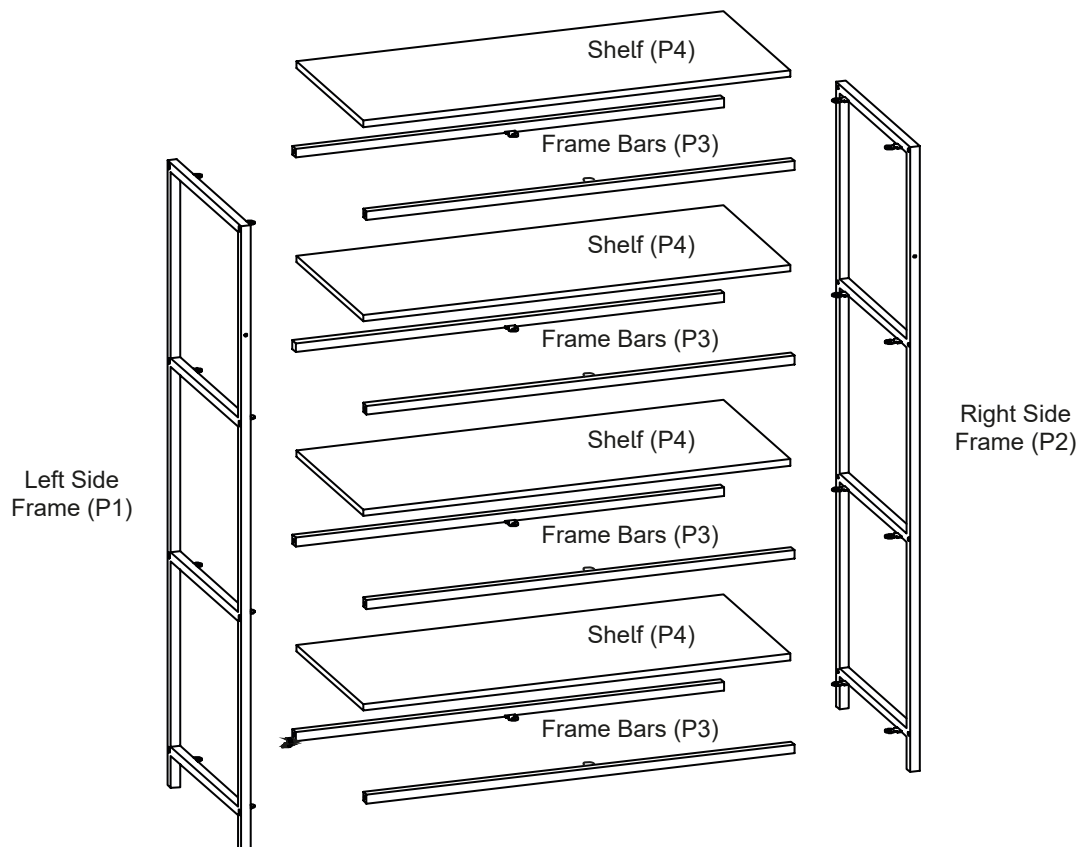



Other tools you need

Phillips head screwdriver



Parts list

Box 1: Left Side Frame (P1); Right Side Frame (P2); Frame Bars (P3 x 8); Shelves (P4 x 4)

								
Frame Screw 16 x (H1)	Shelf Screw 24 x (H2)	Allen Key 1 x (H3)	Wall Strap 2 x (H4)	Nut 2 x (H5)	Washer 4 x (H6)	Wall Strap Screw 2 x (H7)	Spanner 1 x (H8)	Allen Key 1 x (H9)

Step 1

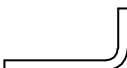
You will need	
	
Frame Screw 16 × (H1)	Allen Key 1 × (H3)

NOTE: Before securing, ensure that the protruding metal screw tabs on the Frame Bars (P3) are rotated so the tabs are facing the inside of the bookcase. These will be used to secure and support the shelves (P4).

NOTE: During transit the metal screw tabs may become slightly bent. Ensure screw tabs on all frame bars are straight before securing screws.

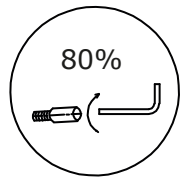
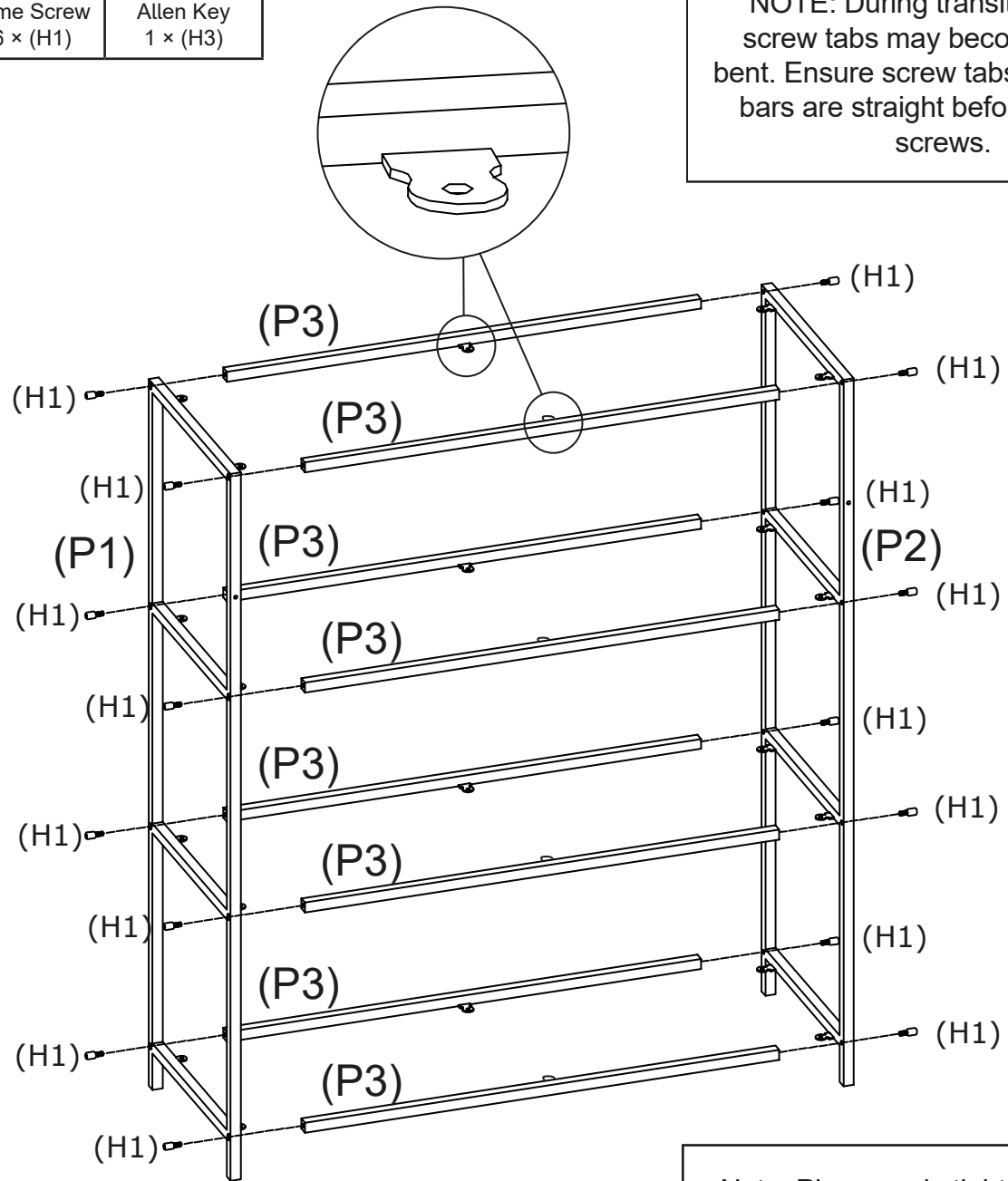

Note: Please only tighten the frame screws (H1) 80%, when shelves have been added, the frame screws (H1) can be tightened 100 %

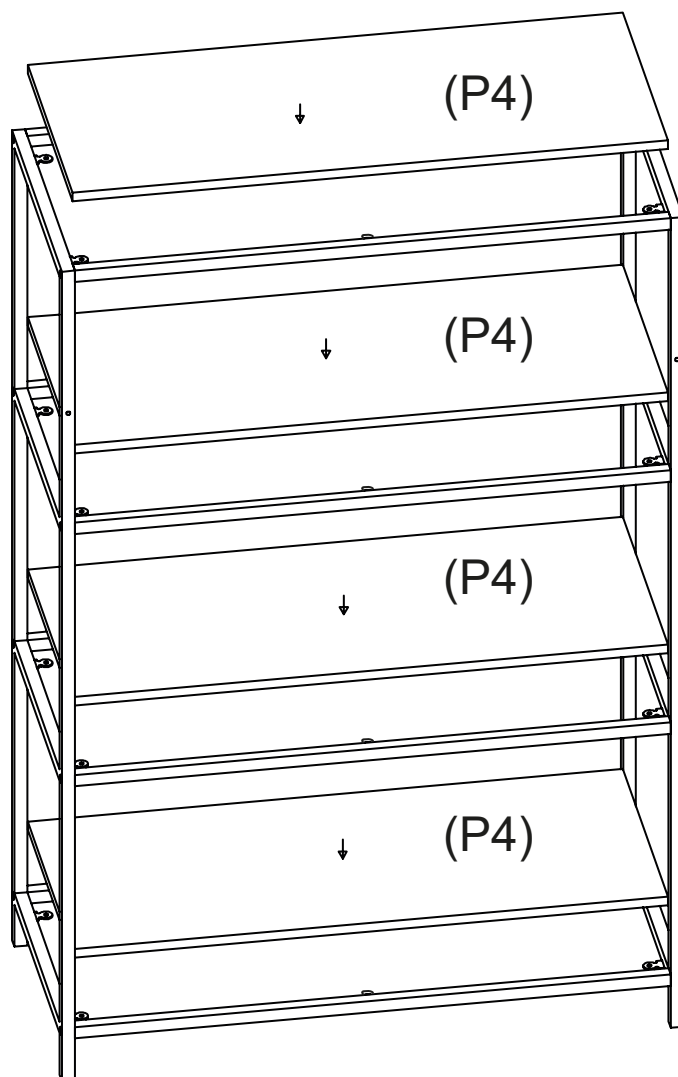
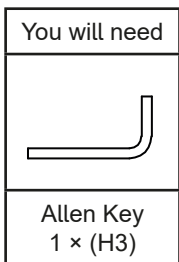

Attach Right and Left Side Frames (P1) and (P2) to Frame Bars (P3) with Frame Screws (H1) by tightening with the Allen Key (H3).

Step 2



Place the Shelves (P4 x 4) into the assembled shelving Frame.
Tighten all Frame Screws (H1) to 100% using the Allen Key (H3).





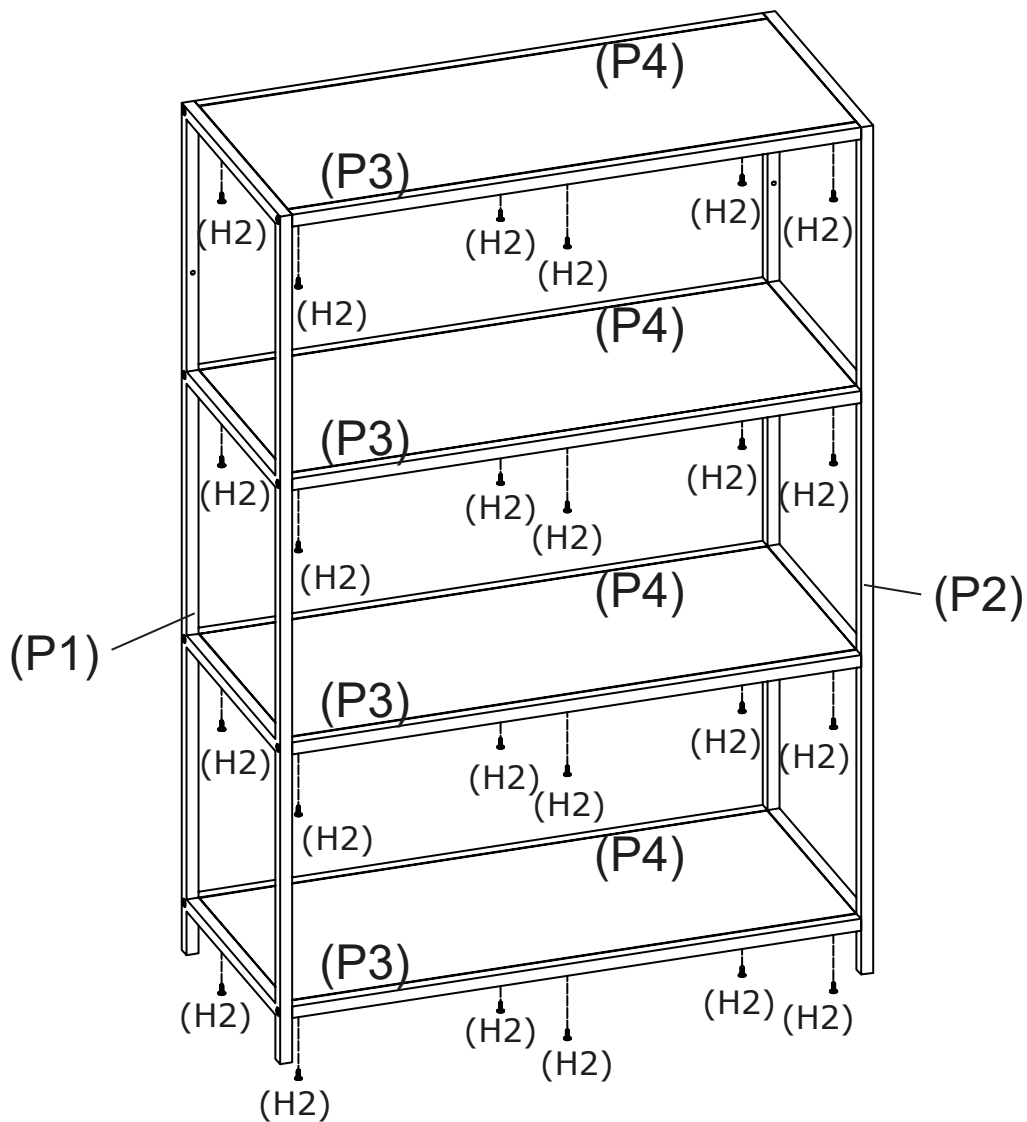

Step 3

You will need	
	
Shelf Screw 24 x (H2)	Phillips Head Screwdriver

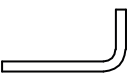

Secure all Shelves (P4) to the assembled bookcase frame panels (P1, P2 + P3) with Shelf Screws (H2) using the Phillips Head Screwdriver

Step 4

You will need	
	
Wall Strap 2 x (H4)	Nut 2 x (H5)
	
Washer 2 x (H6)	Wall Strap Screw 2 x (H7)
	
Allen Key 1 x (H9)	Spanner 1 x (H8)

We strongly advise that you use the wall straps provided to prevent the unit from toppling

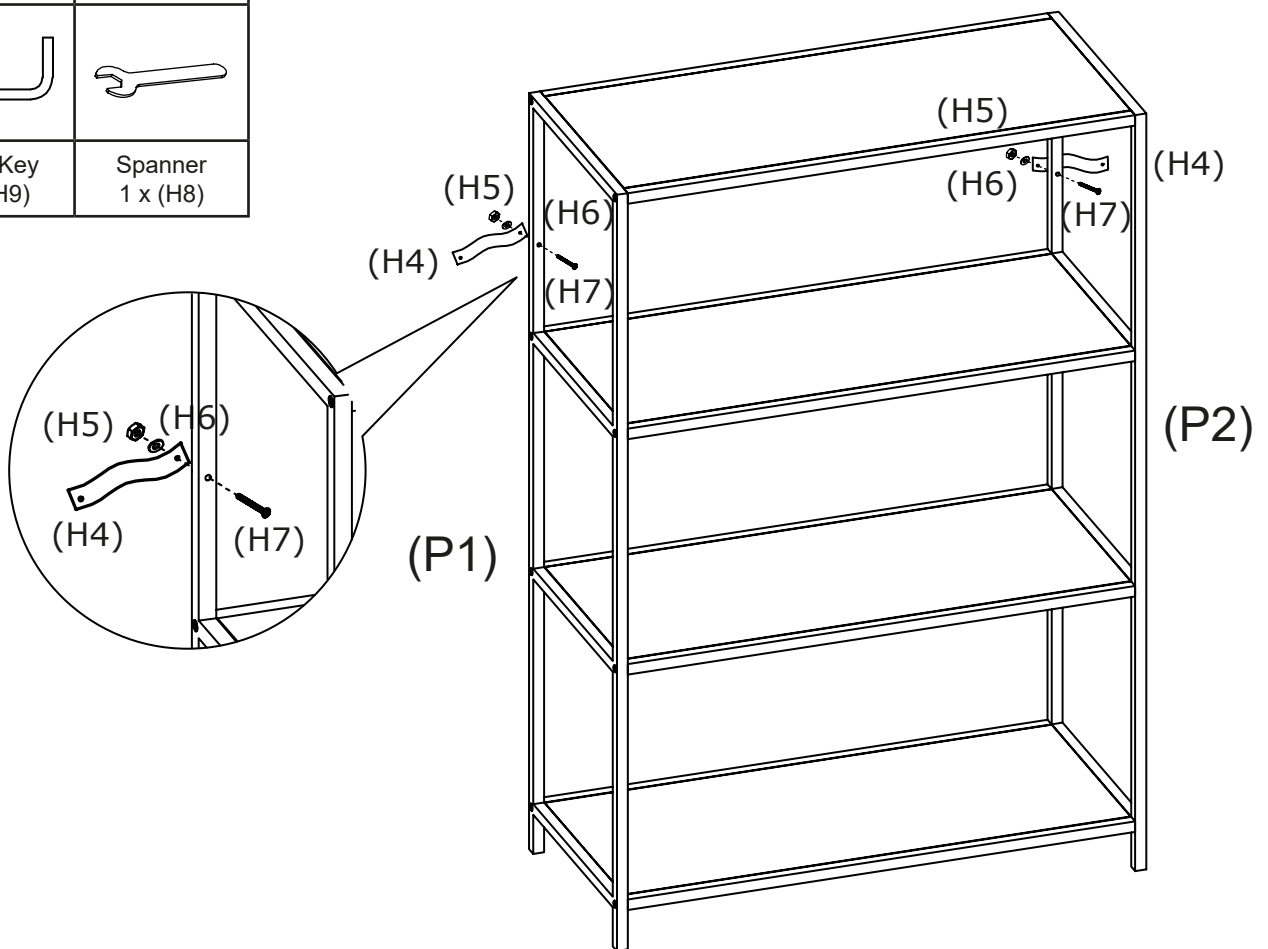

Use Wall Strap Screw (H7), Nut (H5) and Washer (H6) to connect the Wall Strap (H4) to the Right and Left Frames (P1 & P2), using the Allen Key (H9) and Spanner (H8).



Step 5

You will need

Washer 2 × (H6)

Screws and wall plugs are not provided, please use appropriate fixtures for your wall.

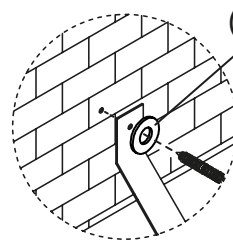
Seek advice from a qualified trades person on how to attach this to your specific wall.

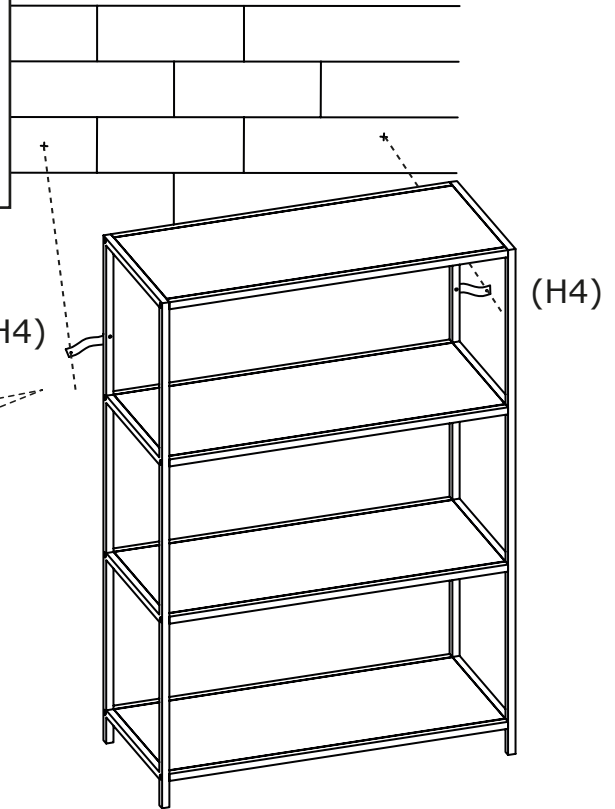

(H6) (H4)



Move furniture to its final position then connect the Wall Strap (H4) to the wall. Make sure it is firmly attached and a snug fit.

Step 6

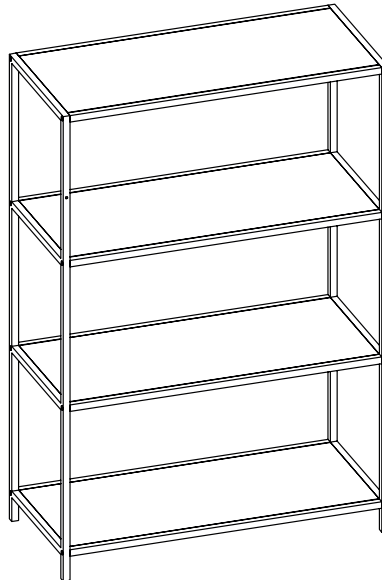

Job Complete!

In the interest of our environment please dispose of all packaging thoughtfully.