



**Fantastic
Furniture**

Version 1.0



Two People

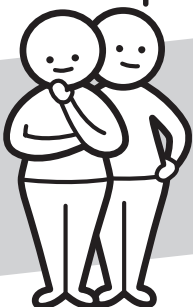

Required

Diamond

Bedside 3 Drawer

fantasticfurniture.com.au



Glass should always be handled with care.

Scratches, chips, sudden changes in temperature and hairline fractures may cause glass to break.

Avoid placing hot or cold items directly onto the table unless using a thick insulation material such as placemats or coasters.

Avoid dropping objects onto the glass. Do not allow hard or pointed objects to come into contact with the glass. Never use the top area as a chopping surface. Do not sit or stand on the glass surface.

Looks like you've found your Fantastic!

We're thrilled you've chosen Fantastic Furniture
to help create a home you'll love!



Fantastic Furniture

Love it? Share it!

Fantastic buy! Share how it looks at home on Instagram for
your chance to win a \$250 Fantastic Furniture Gift Card!

@fantasticfurniture



**Fantastic
Furniture**

Assembly checklist



Read through the instructions carefully before you begin.

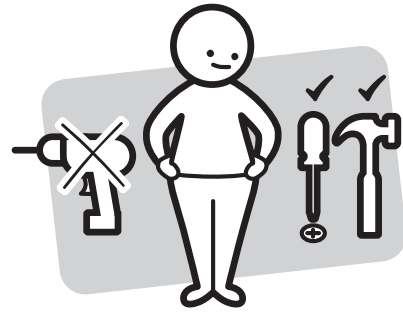

Make sure you have all the required tools. Never use power tools unless instructed.

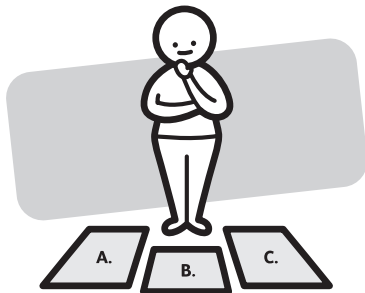

Identify and lay out all of the components before you begin assembly.

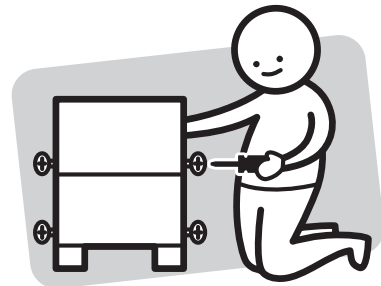

Unless instructed, do not fully tighten screws until the item is fully assembled.

Useful information

- ! Never use power tools unless specifically instructed. They can damage your components or hardware if used incorrectly.
- ! The most common mistakes made during assembly are using the wrong hardware or getting components back to front.
- ! Always use a soft surface (such as carpet or cardboard) when assembling your product to avoid scratching or damaging the surface of the product.
- ! Bulky items such as wardrobes and bunk beds should be assembled in the room they will be used as they may not fit through a door once assembled.
- ! Never use any glue until you are certain that the parts belong together.
- ! Periodically check and re-tighten all fasteners. Check the product care label or website for product care instructions.
- ! If you are having any difficulties assembling your product, missing any hardware or components please visit our website Help Centre for further assistance.
- ! Please see page 2 for any safety requirements or weight restrictions.

What you need

to assemble the product



DO NOT USE



Other tools you need:

Phillips head screwdriver;

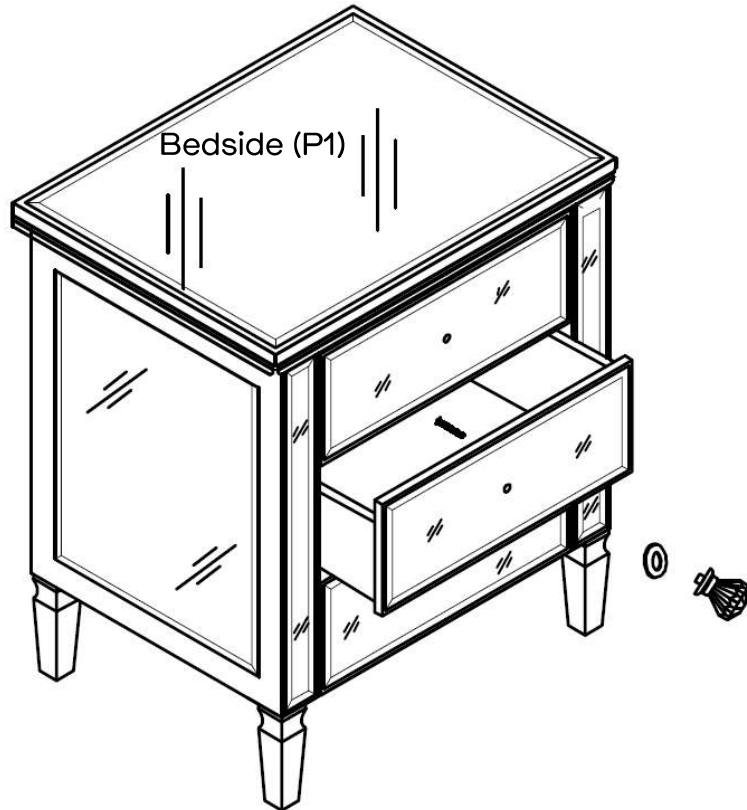

Parts list

Box 1 : 1 x Bedside (P1) ; Hardware.

Hardware



3 x Handles
(H1)







3 x Washers
(H2)



3 x Bolts
(H3)

Step 1

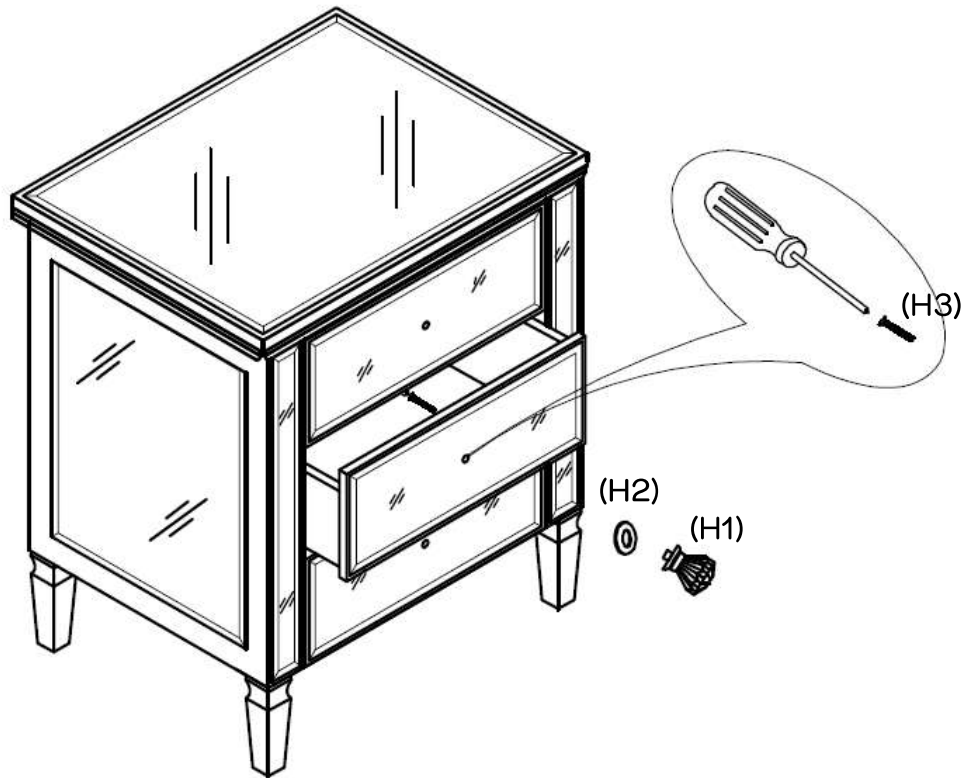

| You will need | |
|---|---|
|  |  |
| 3 x Handles (H1) | 3 x Washers (H2) |
|  |  |
| 3 x Bolts (H3) | Phillips head Screwdriver (not provided) |



Attach the 3 x handles (H1) to the outside of the drawer using 3 x washer (H2) and 3 x bolts (H3) as shown.

Do not over tighten 3 x bolts (H3) as this will cause mirror face of the drawer to crack.

Step 2

| You will need | |
|---|---|
|  |  |
| 1 x Washer (not provided) | 1 x Wall Screw (not provided) |
|  | Washer and wall screw are not included since different surface materials require different attachments. |
| Phillips head Screwdriver (not provided) | |

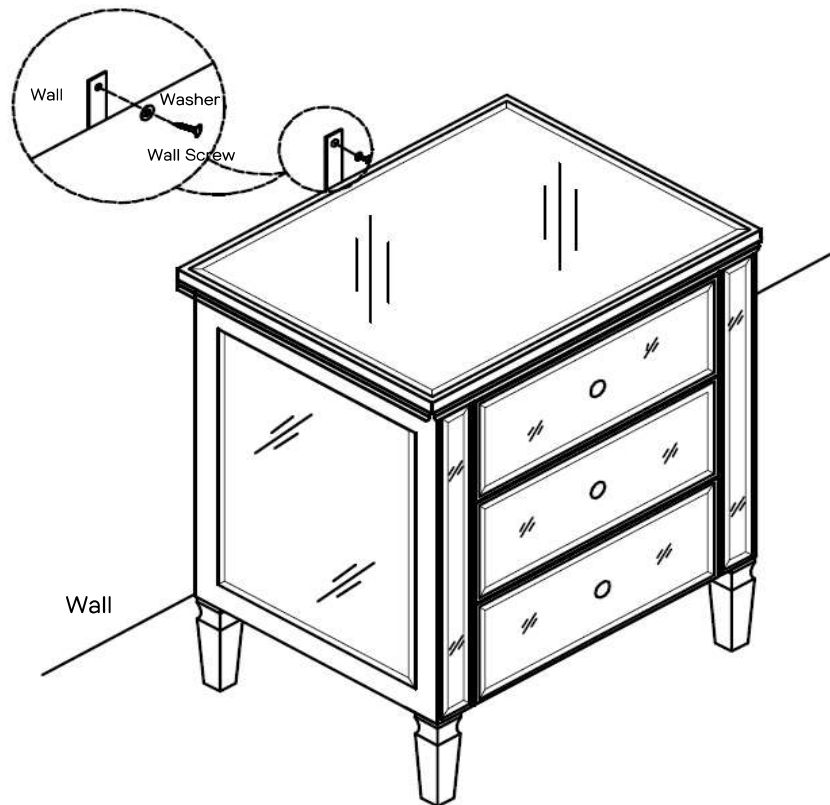

Warning: Ensure the wall strap is attached to avoid serious injury.

To avoid any serious or fatal injury, a wall strap has been provided with this product to prevent toppling. We strongly recommend that this product is permanently fixed to the wall or other suitable surface. Fixing devices are not included since different surface materials require different attachments. Please seek professional advice if you are in doubt of what fixing device to use.

Step 3

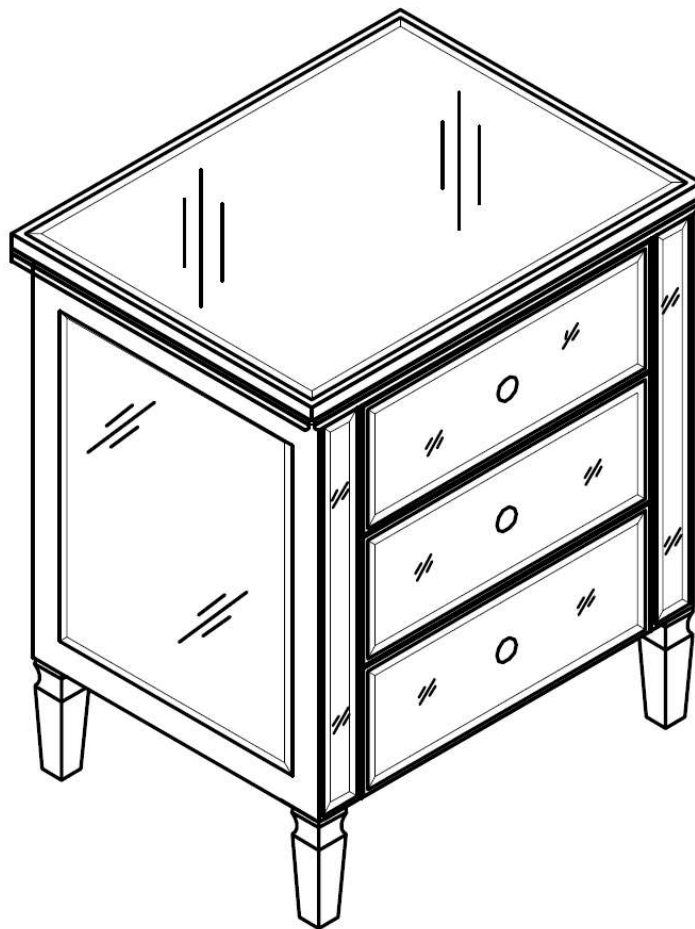

Job complete!

In the interest of our environment please dispose of all packaging thoughtfully.