

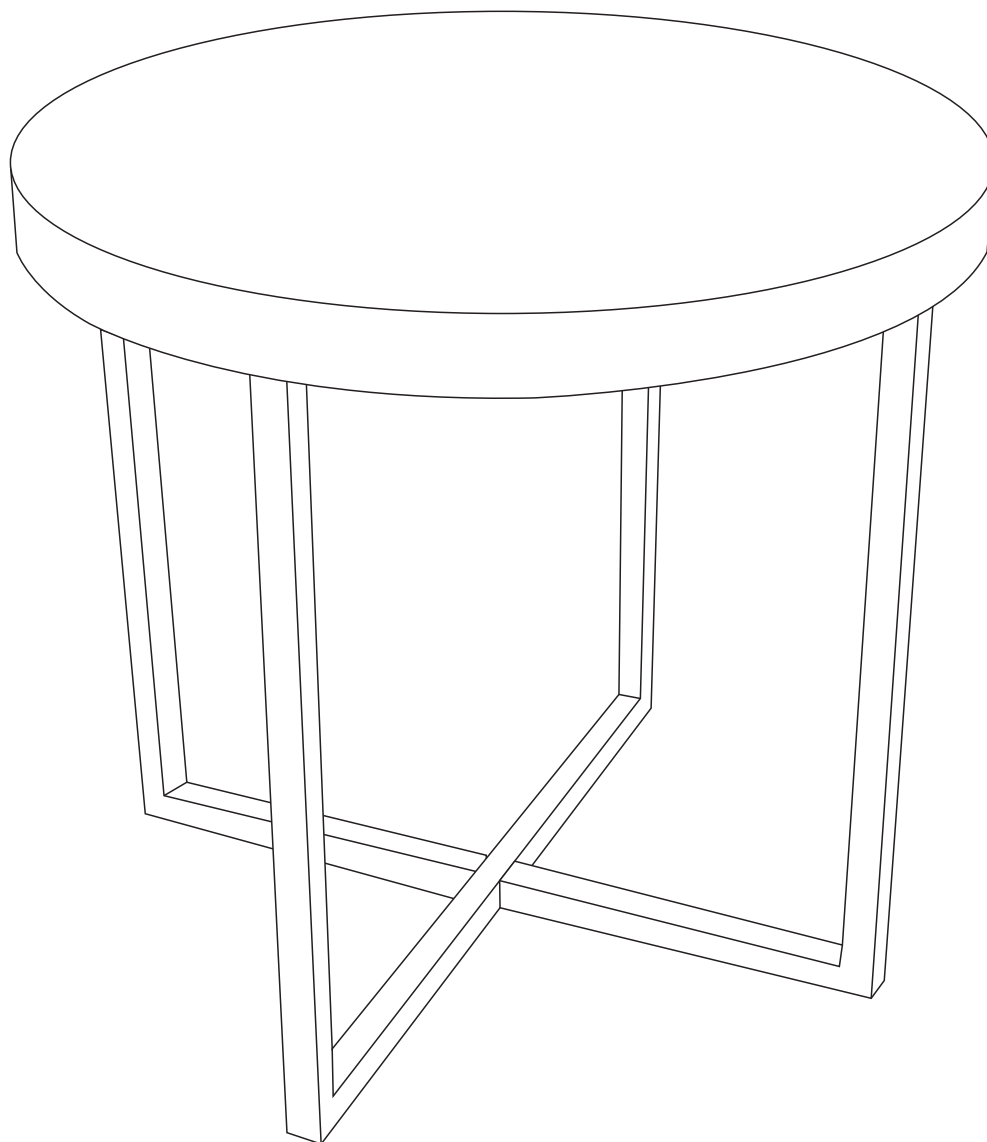

**Fantastic
Furniture**

Version 1.0



Bridge

Lamp Table Round Oak

fantasticfurniture.com.au

Looks like you've found your Fantastic!

We're thrilled you've chosen Fantastic Furniture
to help create a home you'll love!



Fantastic Furniture

Love it? Share it!

Fantastic buy! Share how it looks at home on Instagram for
your chance to win a \$250 Fantastic Furniture Gift Card!

@fantasticfurniture

Assembly Checklist



Read through the instructions carefully before you begin.

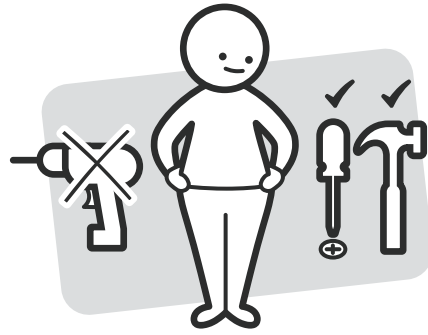

Make sure you have all the required tools. Never use power tools unless instructed.

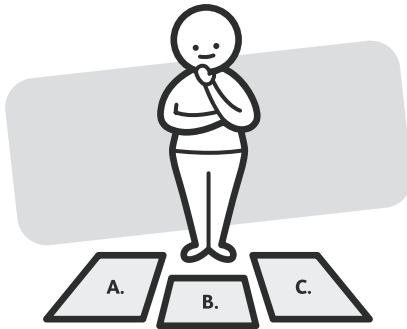

Identify and lay out all of the components before you begin assembly.

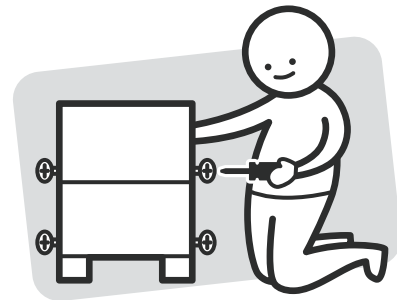

Unless instructed, do not fully tighten screws until the item is fully assembled.

Useful Information

- ! Never use power tools unless specifically instructed. They can damage your components or hardware if used incorrectly.
- ! The most common mistakes made during assembly are using the wrong hardware or getting components back to front.
- ! Always use a soft surface (such as carpet or cardboard) when assembling your product to avoid scratching or damaging the surface of the product.
- ! Bulky items such as wardrobes and bunk beds should be assembled in the room they will be used in as they may not fit through a door once assembled.
- ! Never use any glue until you are certain that the parts belong together.
- ! Periodically check and re-tighten all fasteners. Check the product care label or website for product care instructions.
- ! If you are having any difficulties assembling your product, missing any hardware or components please visit our website Help Centre for further assistance.
- ! Please see page 2 for any safety requirements or weight restrictions.

What you need to assemble the product

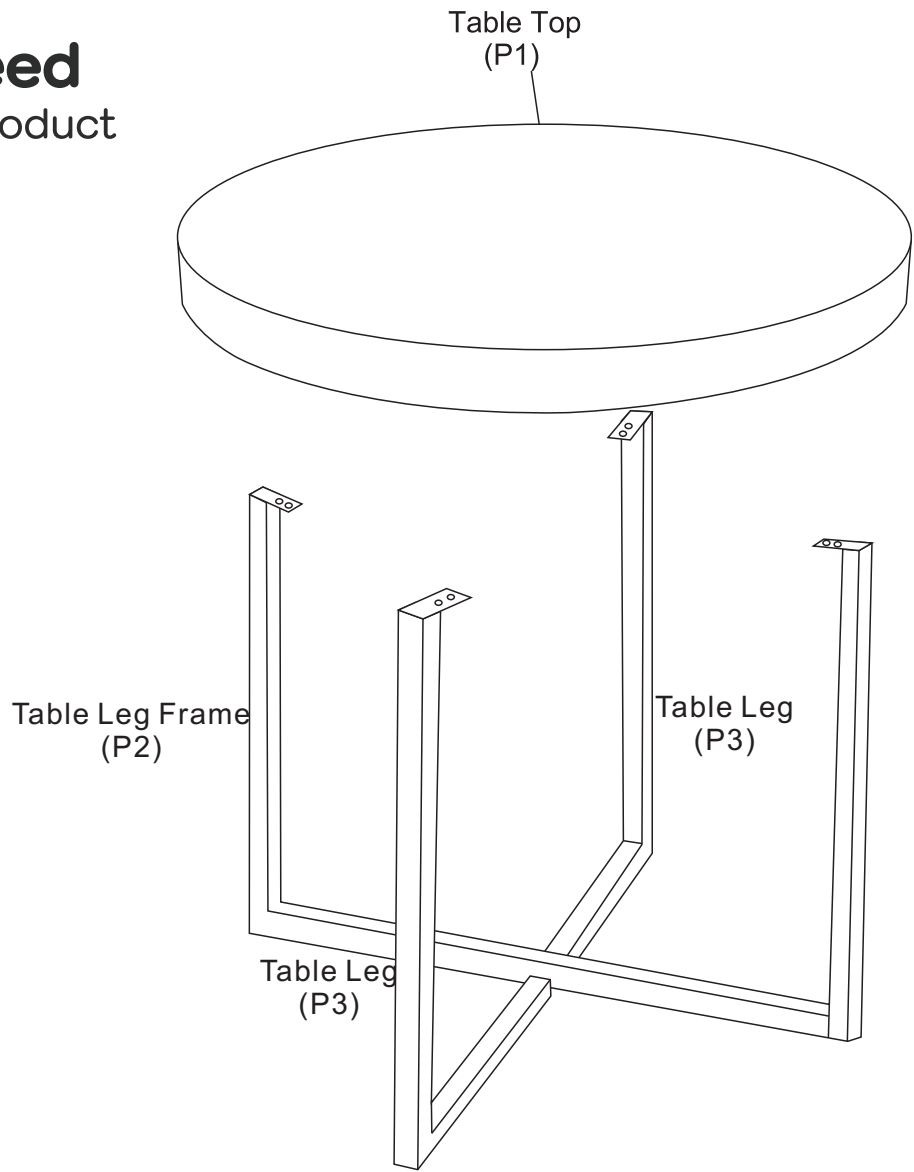

Parts list

- Table Top(P1)
- Table Leg Frame (P2)
- 2 x Table Legs(P3)

Hardware Pack

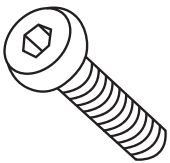

14 x Bolts
(H1)

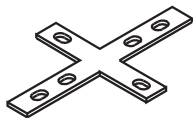

1 x Connector
(H2)

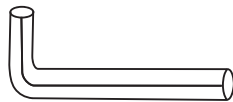

Allen Key
(H3)



8 x Washers
(H4)



4 x Levelling Feet
(H5)

Step 1

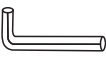
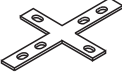
You will need:	
	
2 x Bolts (H1)	1 x Allen Key (H3)
	
1 x Connector (H2)	

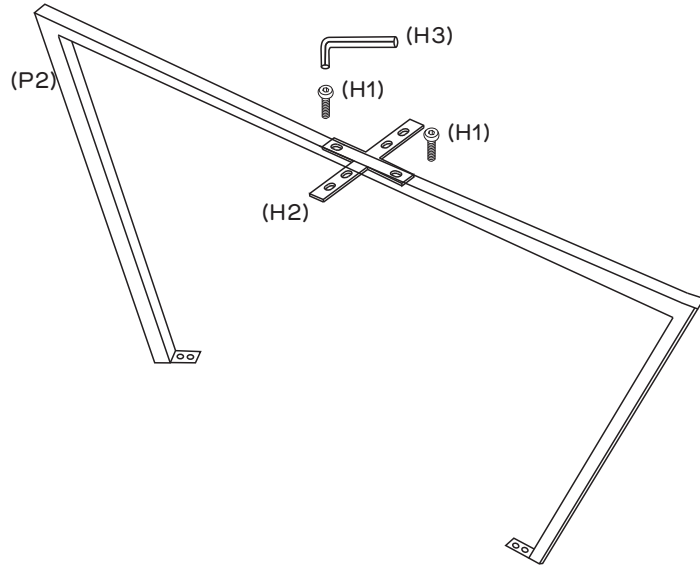

Align connector (H2) to table leg frame (P2) as shown. Attach the connector (H2) to the table leg frame (P2) using 2 x bolts (H1), using the allen key, Do not fully tighten the bolts (H1).

Step 2

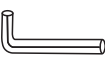
You will need:	
	
4 x Bolts (H1)	1 x Allen Key (H3)

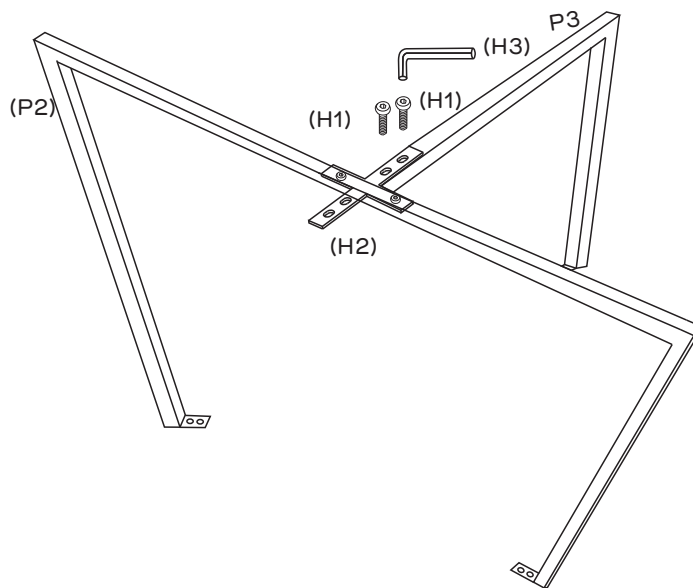

Align 1 x table leg (P3) to the connector (H2) and attach using 2 x bolts (H1), using the allen key, Do not fully tighten the bolts (H1). Repeat the same process for the other table leg (P3).

Step 3



You will need:	
	
8 x Bolts (H1)	1 x Allen Key (H3)
	
8 x Washers (H4)	4 x Levelling Feet (H5)

Note: We recommend assembling the table on a soft surface to minimise the risk of damaging the table.

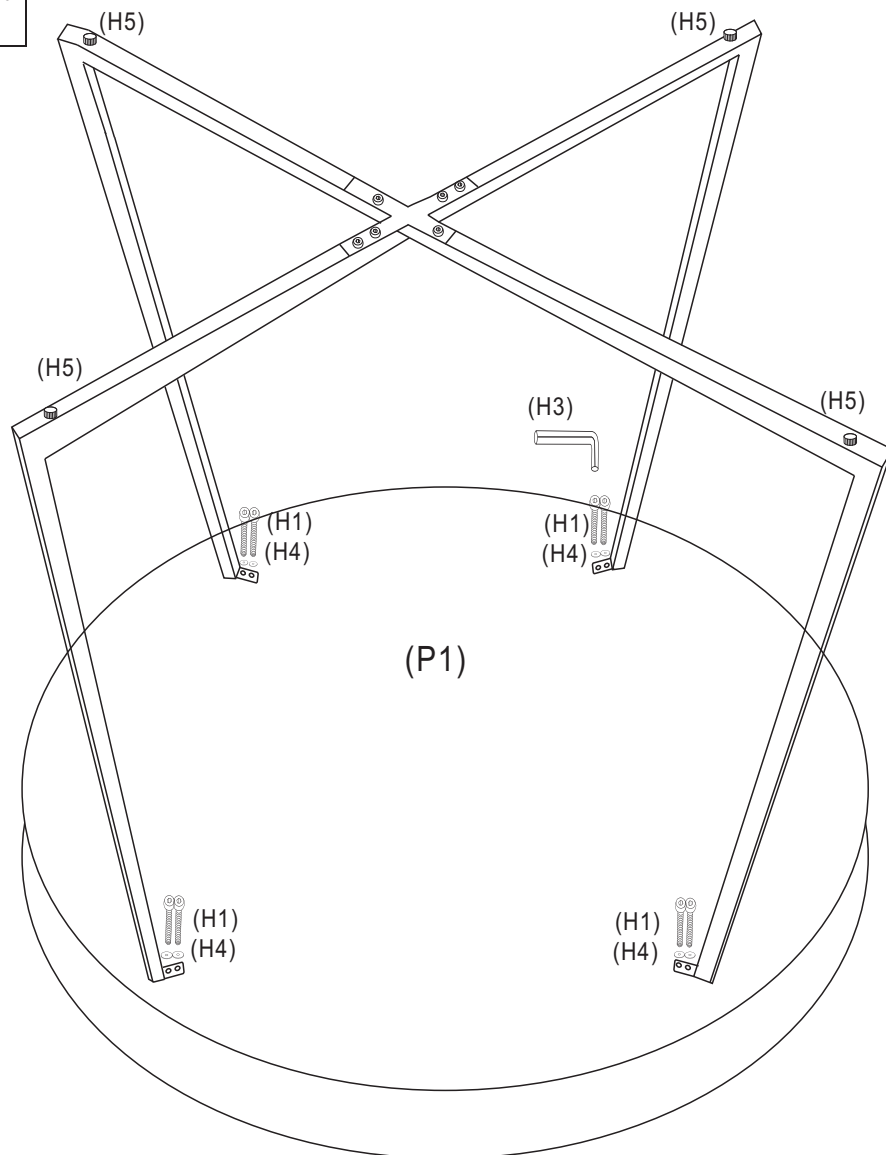

Align the assembled legs (P2, P3) onto the table top (P1) and attach using 8 x bolts (H1) and 8 x washers (H4), using the allen key (H3). Do not fully tighten the bolts (H1).

Attach 4 x levelling feet (H4) to the bottom of each leg (P2, P3) by screwing clockwise until tight.

With assistance, turn the table over. Ensure the frame is stable. You may now fully tighten all bolts (H1) using allen key (H3).

If required, the levelling feet (H4) can be adjusted by turning anti-clockwise or clockwise as required so the table is level with the ground.

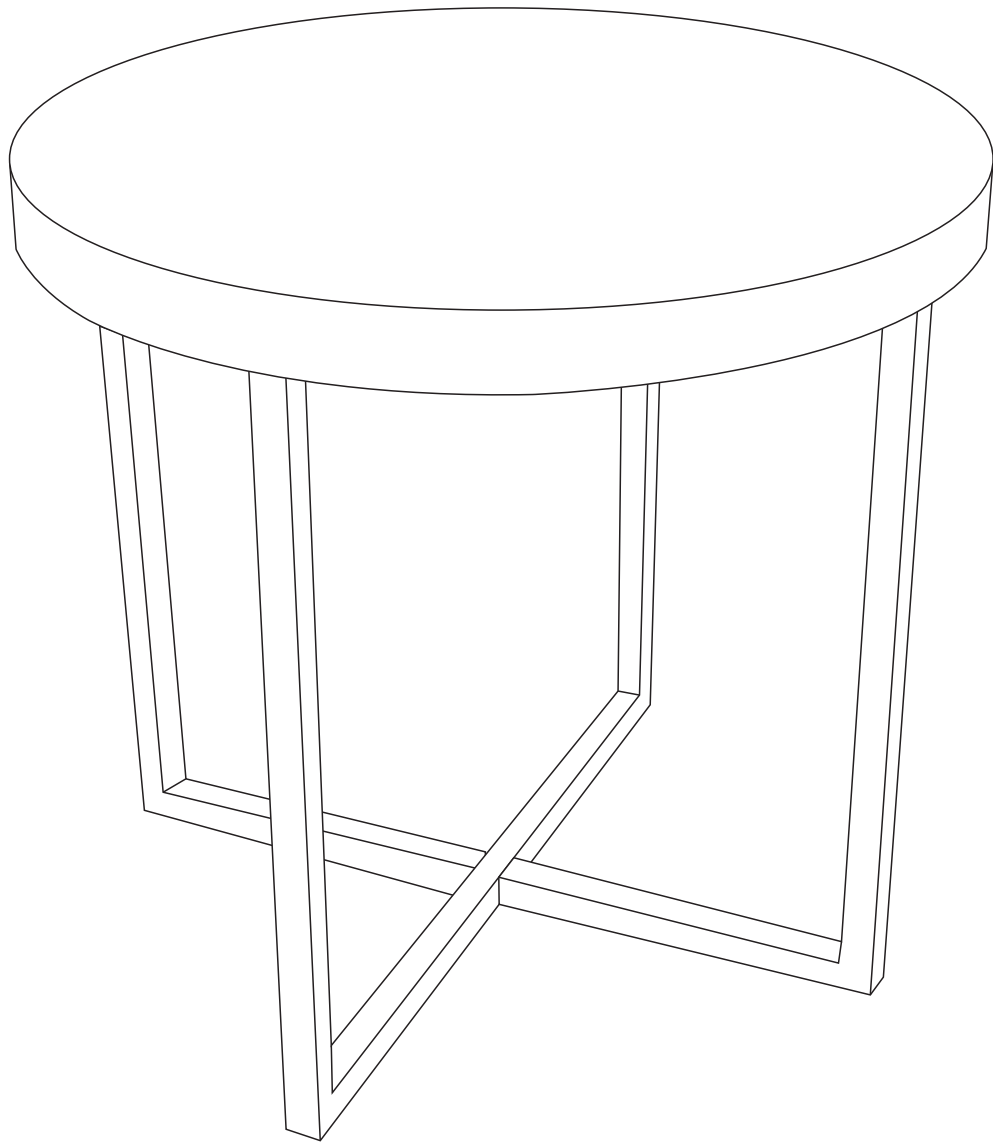

Job Complete!

In the interest of our environment please dispose of all packaging thoughtfully.