

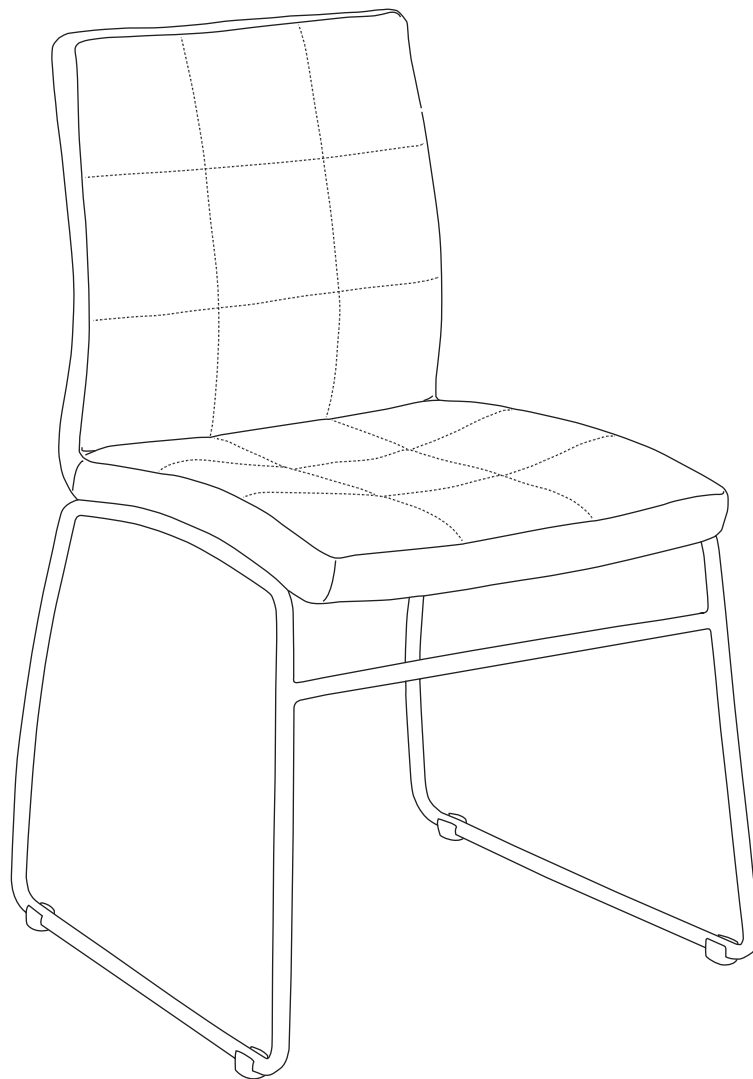

Version 1.0



# ESPEN

Chair

[www.fantasticfurniture.com.au](http://www.fantasticfurniture.com.au)

**CAUTION:**

Use this product for seating one person at a time.  
Do not stand on, or use this chair as a step ladder.  
Do not rock on chair as this may result in injury.  
This product should be checked periodically to ensure  
alle components are secure and all hardware is tight.

**RECOMMENDED WEIGHT CAPACITY 120 KG**

# Enjoy

Your purchase from  
Australia's Best Value Furniture Store



# Assembly checklist



Read through the instructions carefully before you begin.



Make sure you have all the required tools. Never use power tools unless instructed.



Identify and lay out all of the components before you begin assembly.

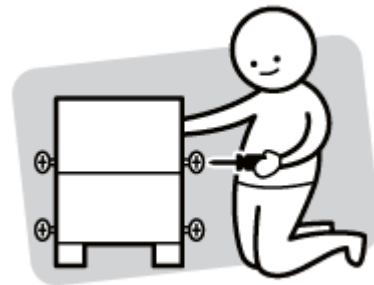

Unless instructed, do not fully tighten screws until the item is fully assembled.

## Useful Information

- ! Never use power tools unless specifically instructed. They can damage your components or hardware if used incorrectly
- ! The most common mistakes made during assembly are using the wrong hardware or getting components back to front.
- ! Always use a soft surface (such as carpet or cardboard) when assembling your product to avoid scratching or damaging the surface of the product.
- ! Bulky items such as wardrobes and bunk beds should be assembled in the room they will be used in as they may not fit through a door once assembled.
- ! Never use any glue until you are certain that the parts belong together.
- ! Periodically check and re-tighten all fasteners. Check the product care label or website for product care instructions.
- ! If you are having any difficulties assembling your product, missing any hardware or components please visit our website Help Centre for further assistance.

# What you need

to assemble the product



DO NOT USE

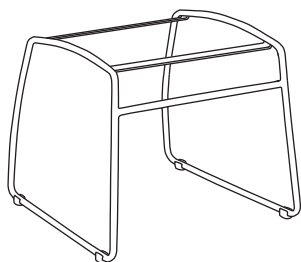

Base  
1 x (P1)

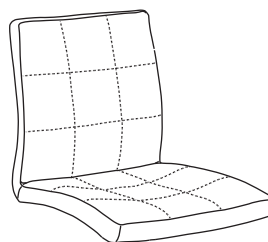

Seat/back  
1 x (P2)

## Parts list

Box 1: Base (P1); Seat/back (P2).

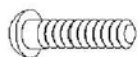

Bolt  
4 x (H1)





Flat Washer  
4 x (H2)

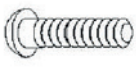

Allen Key  
1 x (H3)

# Step 1

You will need	
	
4 x (H1)	4 x (H2)
	
1 x (H3)	

Attach seat/back (P2) to base (P1) using washers (H2), bolts (H1) and allen key (H3), align the bolts to the nuts on bottom seat first, make sure the sides of the seat and frame are well aligned before fully tightening all the bolts.

make sure the seat is well aligned on both sides

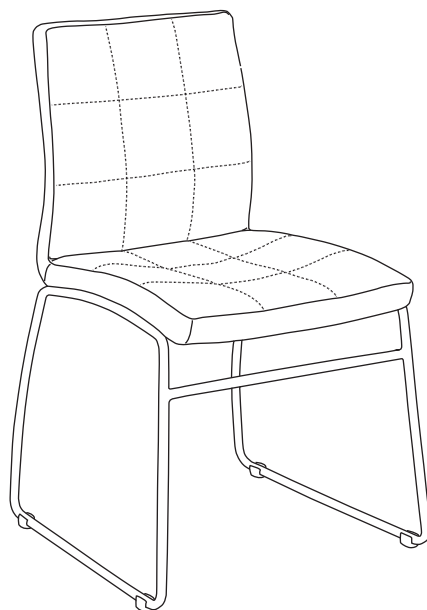
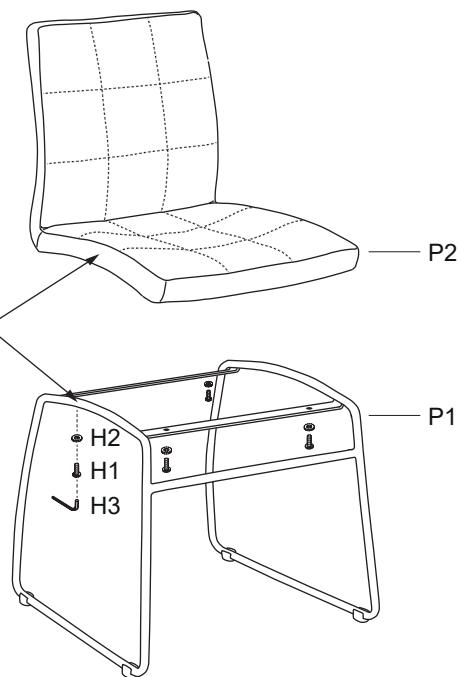

## Job Complete!

In the interest of our environment please dispose of all packaging thoughtfully.