

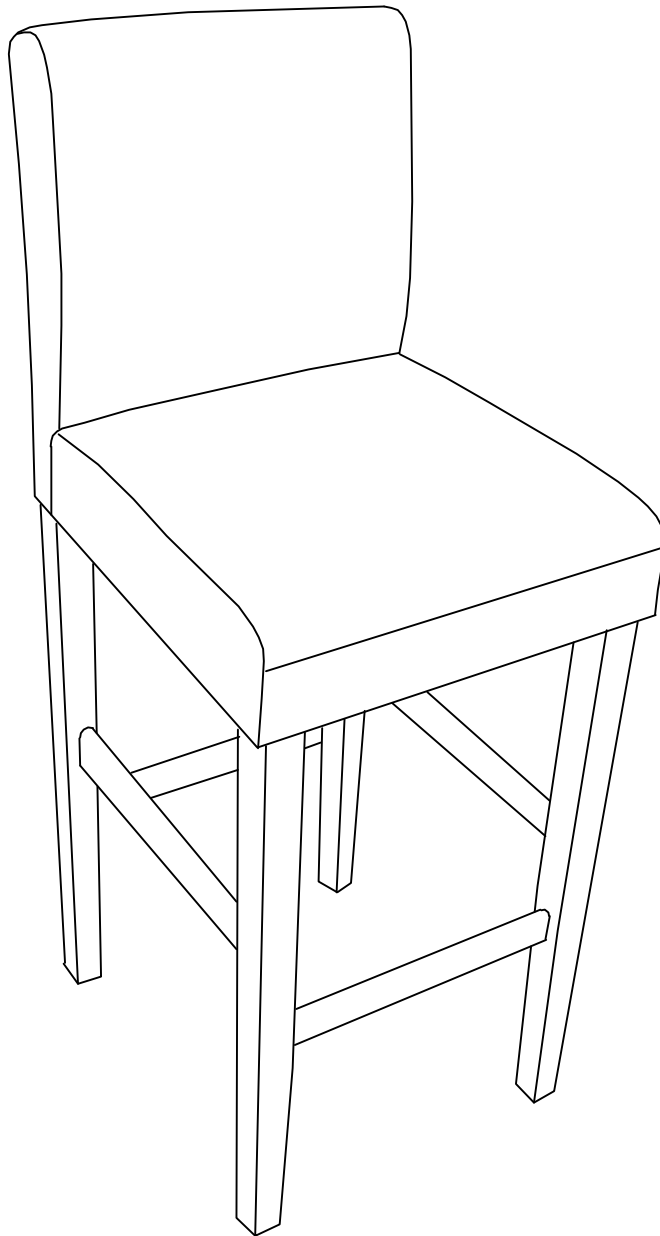

Version 1.0



MADISON

Bar stool 1 STR

www.fantasticfurniture.com.au

CAUTION

Do not stand on, or use this chair as a step ladder.
Use this product for seating one person at a time.
This product should be checked periodically to ensure all
components are secure and all hardware is tight.

RECOMMENDED WEIGHT CAPACITY 120 KG

Enjoy

Your purchase from
Australia's Best Value Furniture Store



Assembly checklist



Read through the instructions carefully before you begin.



Make sure you have all the required tools. Never use power tools unless instructed.



Identify and lay out all of the components before you begin assembly.

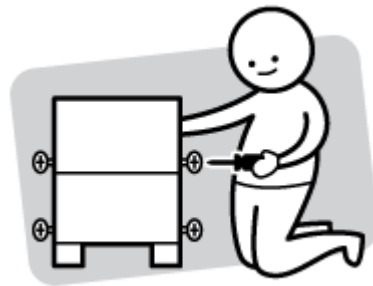

Unless instructed, do not fully tighten screws until the item is fully assembled.

Useful Information

- ! Never use power tools unless specifically instructed. They can damage your components or hardware if used incorrectly.
- ! The most common mistakes made during assembly are using the wrong hardware or getting components back to front.
- ! Always use a soft surface (such as carpet or cardboard) when assembling your product to avoid scratching or damaging the surface of the product.
- ! Bulky items such as wardrobes and bunk beds should be assembled in the room they will be used in as they may not fit through a door once assembled.
- ! Never use any glue until you are certain that the parts belong together.
- ! Periodically check and re-tighten all fasteners. Check the product care label or website for product care instructions.
- ! If you are having any difficulties assembling your product, missing any hardware or components please visit our website Help Centre for further assistance.

What you need

to assemble the product



DO NOT USE

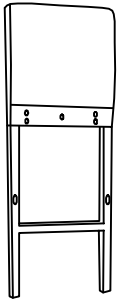

1 x Back Frame
(P1)

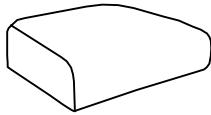

1 x Seat Frame
(P2)



2 x Front Legs
(P3)

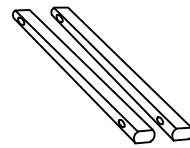

2 x Side Rails
(P4)

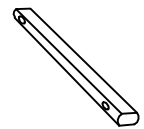

1 x Front Rail
(P5)

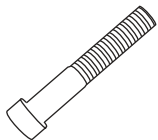

9 x Medium Bolts
(H1)

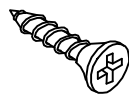

6 x Screws
(H2)



9 x Washers
(H3)

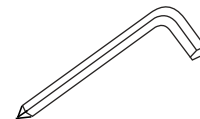

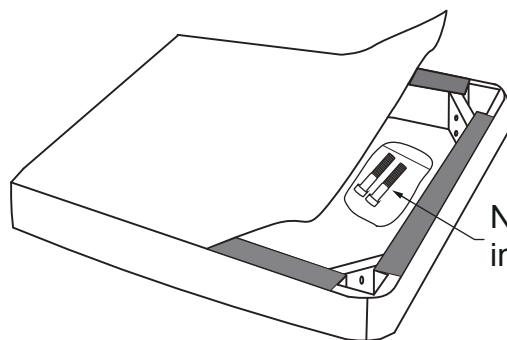

Allen Key



Note: Hardware pack
inside of seat

Please make sure you have all these parts before you start.

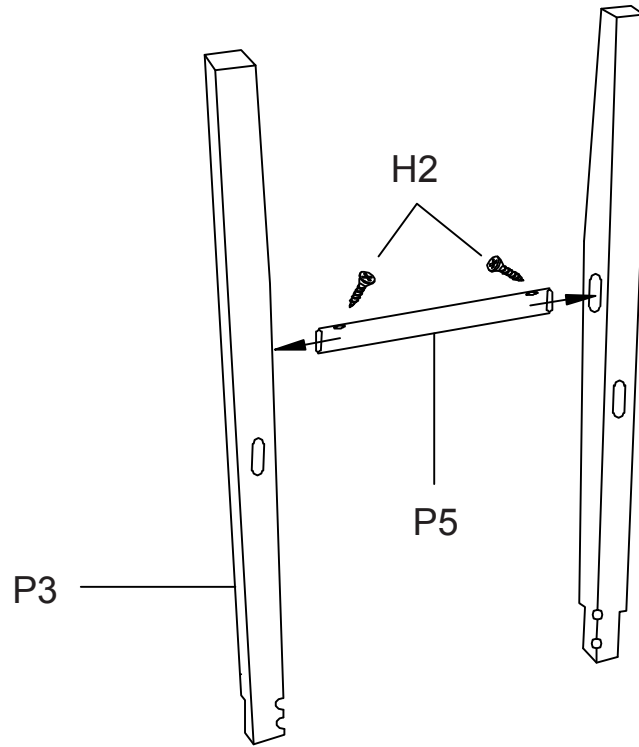

Step 1

You will need	
	
2 x Screws (H2)	Allen key

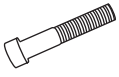

Insert Front Rail (P5) into the corresponding holes in Front legs (P3). Attach using 2 x Screws (H2) . Do not fully tighten screws, leave a little loose at this stage.

Step 2

You will need	
	
4 x Washers (H3)	4 x Medium Bolts (H1)
	
Allen key	

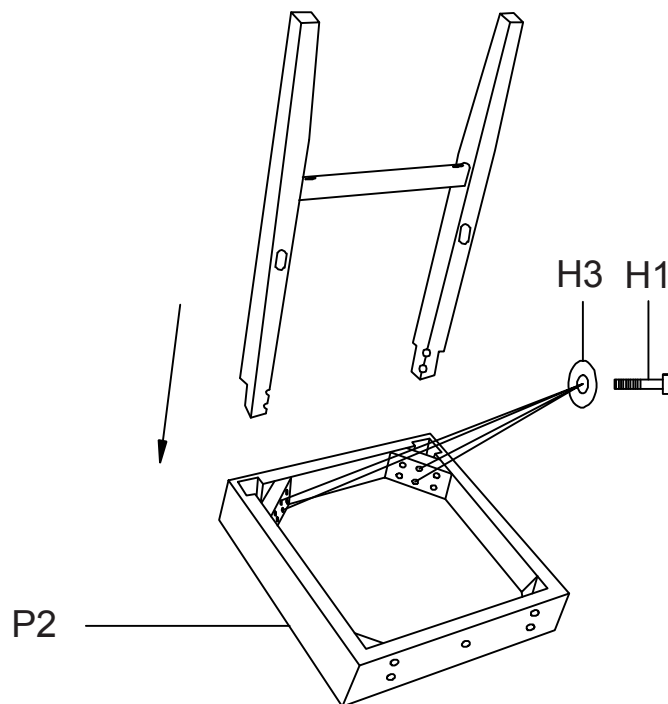

Insert 4 x medium Bolts (H1) and 4 x Washers (H3). Do not fully tighten bolts, leave a little loose at this stage.

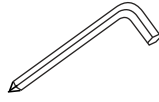

Step 3

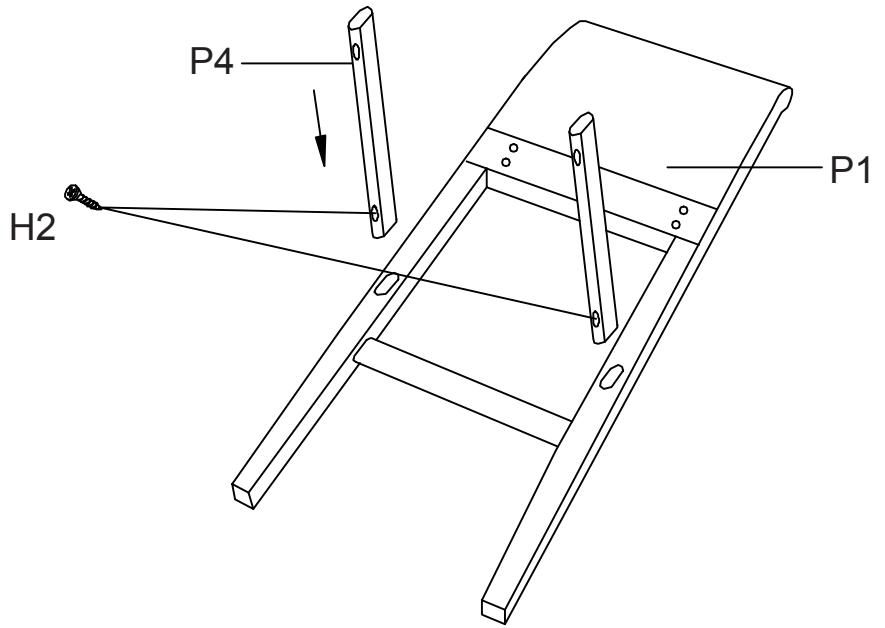
You will need	
	
2 x Screws (H2)	Allen key

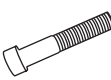

Insert Side Rails (P4) into the corresponding holes in Back frame (P1). Attach using 2 x Screws (H2) . Do not fully tighten bolts, leave a little loose at this stage.

Step 4

You will need	
	
5 x Washers (H3)	5x Medium Bolts (H1)
	
Allen key	

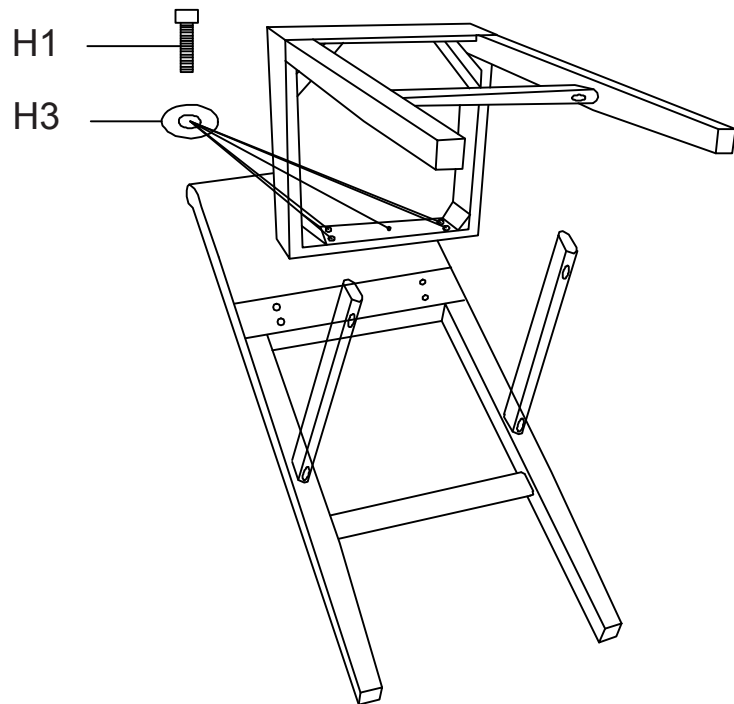

Attach front section from Step 2 to Back section from Step 3 using 5 x medium Bolts (H1) and 5 x Washers (H3). Do not fully tighten bolts, leave a little loose at this stage

Step 5

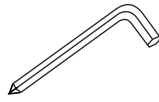
You will need	
	
2 x Screws (H2)	Allen key

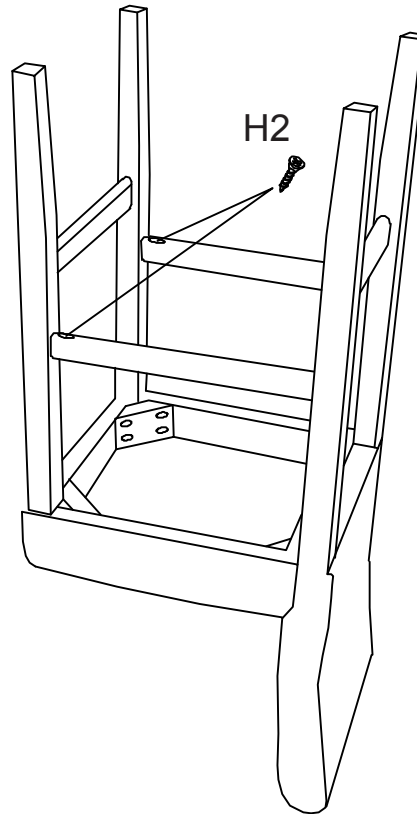

Attach side rails (P4) to front legs using 2 x Screws (H2) .

Step 6

You will need

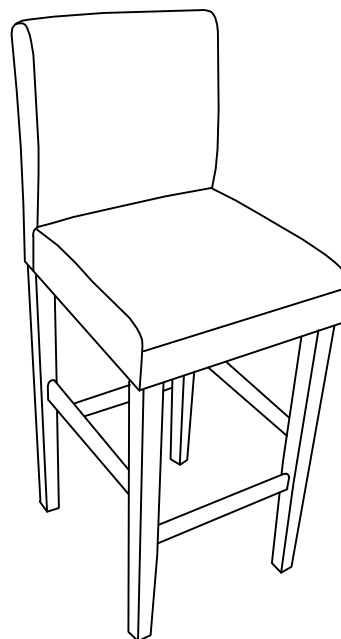
Allen key

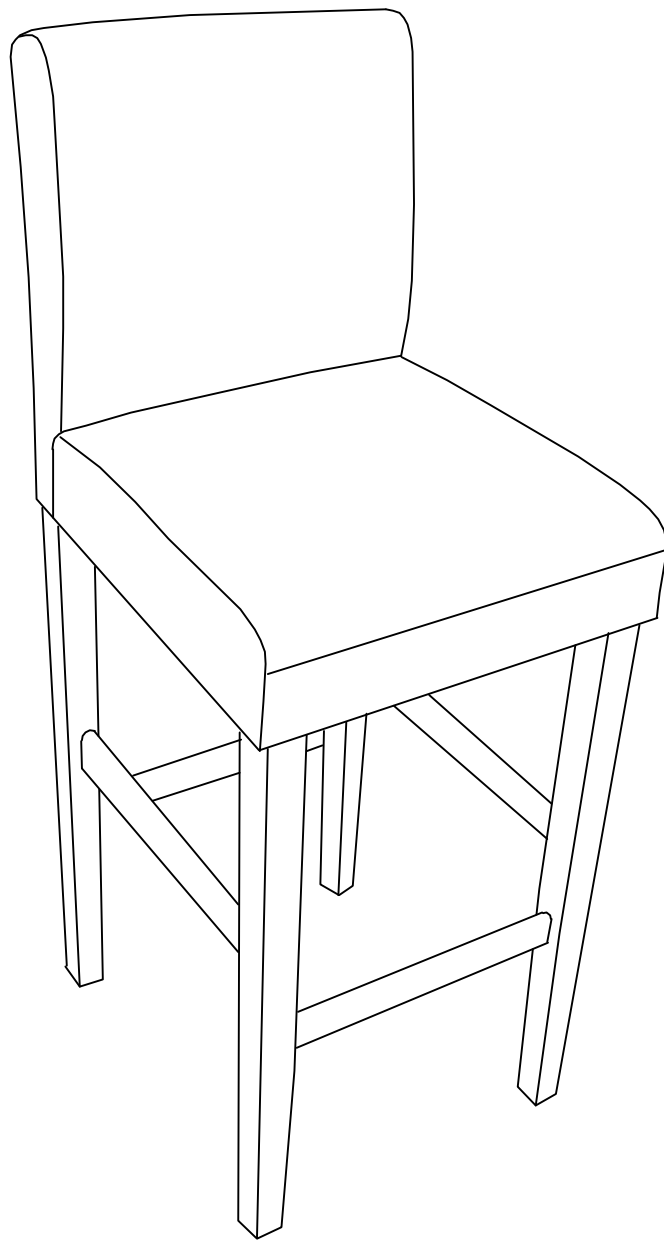

Apply downward pressure on the seat pad to ensure the chair is level before tightening all bolts and screws firmly with Allen Key and Screw Driver

Step 7



Job Complete !

In the interest of our environment
Please dispose of all packaging thoughtfully