

# ALFA

UTILITY  
5 SHELF

[www.fantasticfurniture.com.au](http://www.fantasticfurniture.com.au)

780-A15FF1-0

TWO PEOPLE

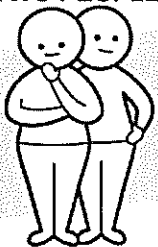

REQUIRED

# Assembly checklist



Read through the instructions carefully before you begin.

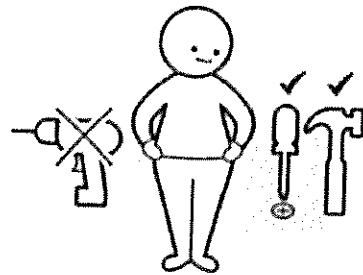

Make sure you have all the required tools. Never use power tools unless instructed.

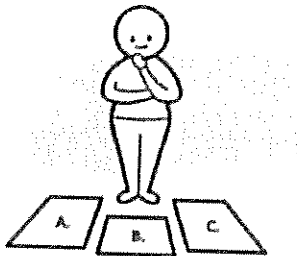

Identify and lay out all of the components before you begin assembly.

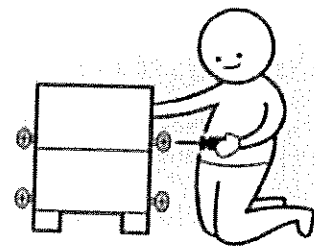

Unless instructed, do not fully tighten screws until the item is fully assembled.

## Useful Information

- ! Never use power tools unless specifically instructed. They can damage your components or hardware if used incorrectly.
- ! The most common mistakes made during assembly are using the wrong hardware or getting components back to front.
- ! Always use a soft surface (such as carpet or cardboard) when assembling your product to avoid scratching or damaging the surface of the product.
- ! Bulky items such as wardrobes and bunk beds should be assembled in the room they will be used in as they may not fit through a door once assembled.
- ! Never use any glue until you are certain that the parts belong together.
- ! Periodically check and re-tighten all fasteners. Check the product care label or website for product care instructions.
- ! If you are having any difficulties assembling your product, missing any hardware or components please visit our website Help Centre for further assistance.

# What you need

to assemble the product



DO NOT USE



## Other tools you need



Phillips head screwdriver.

## Parts list

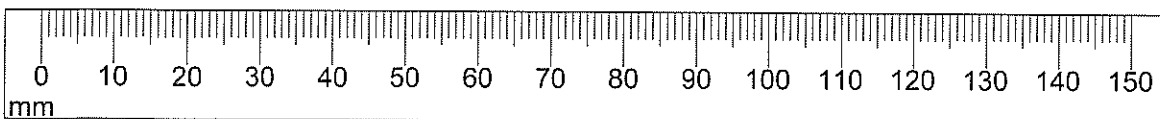
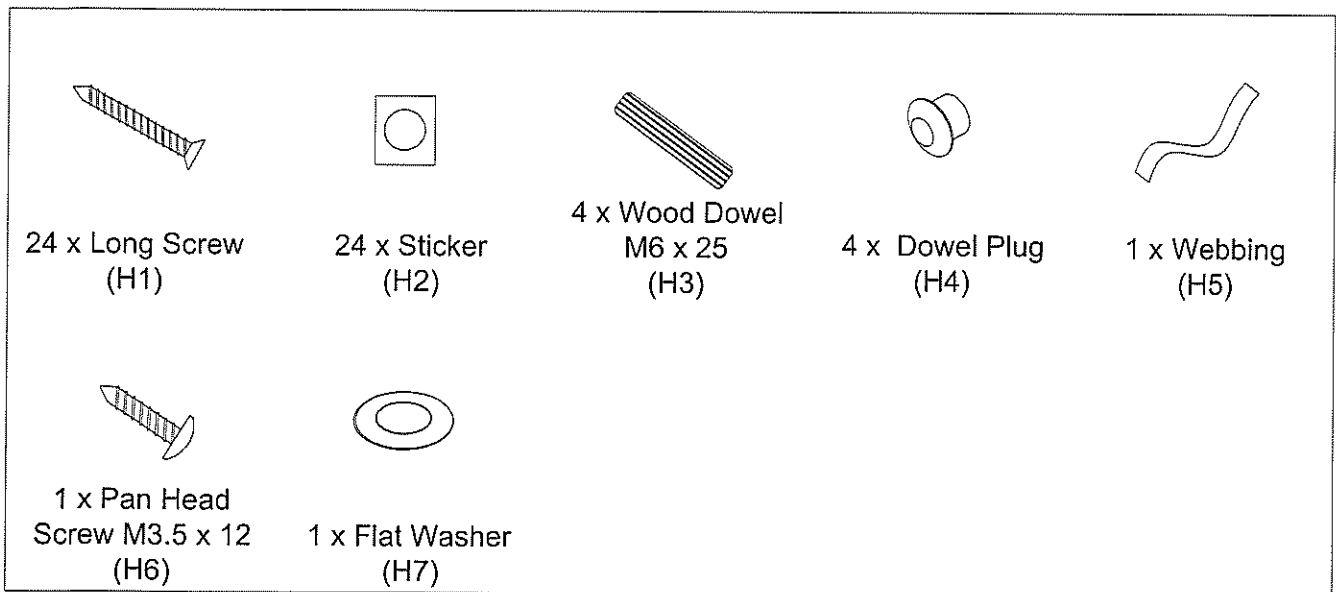
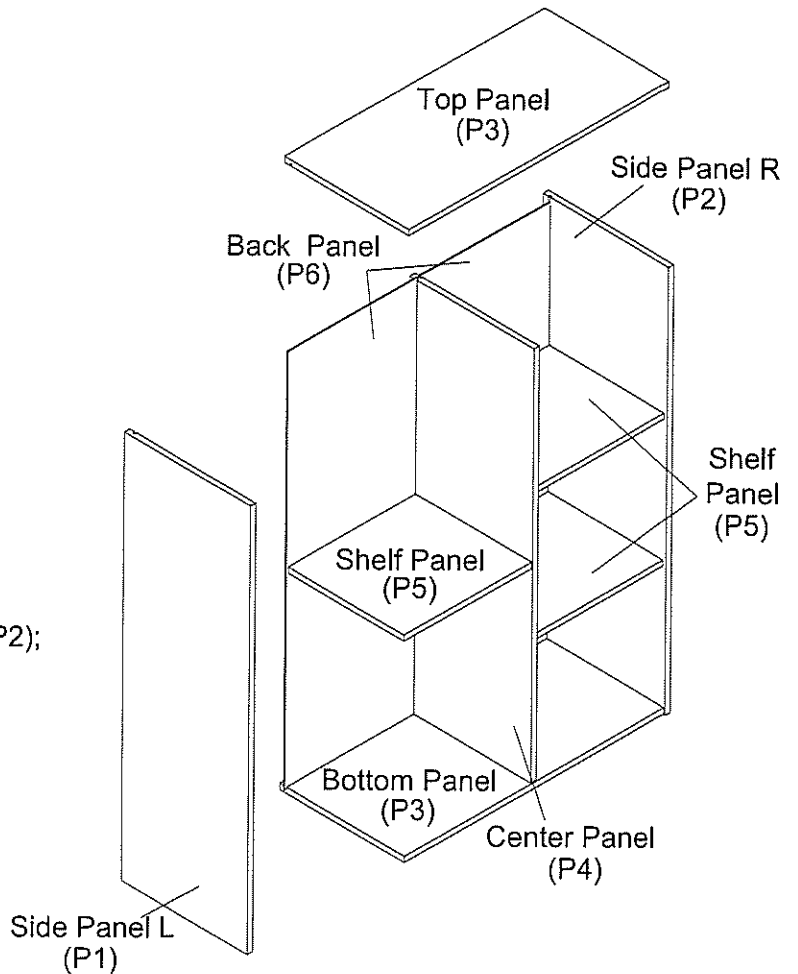
**Box 1:** Side Panel L (P1); Side Panel R (P2);  
Top Panel (P3); Bottom Panel (P3)  
Center Panel (P4); Shelf Panel (P5)  
Back Panel (P6).





# Step 1

You will need	
	
2 x Long Screw (H1)	Phillips head screwdriver

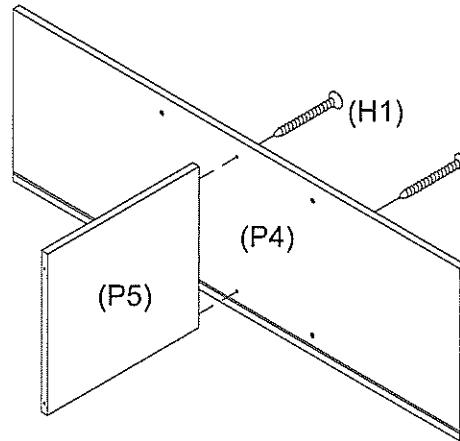
Attach Shelf Panel (P5) to Center Panel (P4) using screws (H1).





# Step 2

You will need	
	
4 x Long Screw (H1)	Phillips head screwdriver

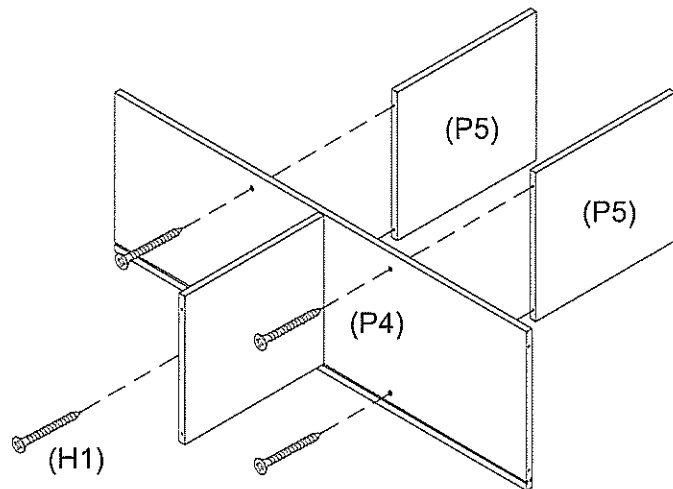
Attach Shelf Panels (P5) to Center Panel (P4) using screws (H1).

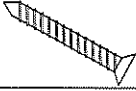

# Step 3

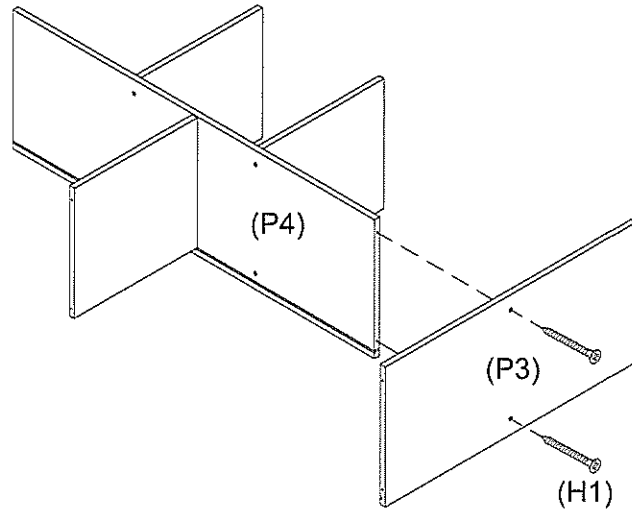

You will need	
	
2 x Long Screw (H1)	Phillips head screwdriver

Attach Top Panel (P3) using screws (H1).



---

# Step 4

You will need	
	
2 x Long Screw (H1)	Phillips head screwdriver

Attach Bottom Panels (P3) using screws (H1).

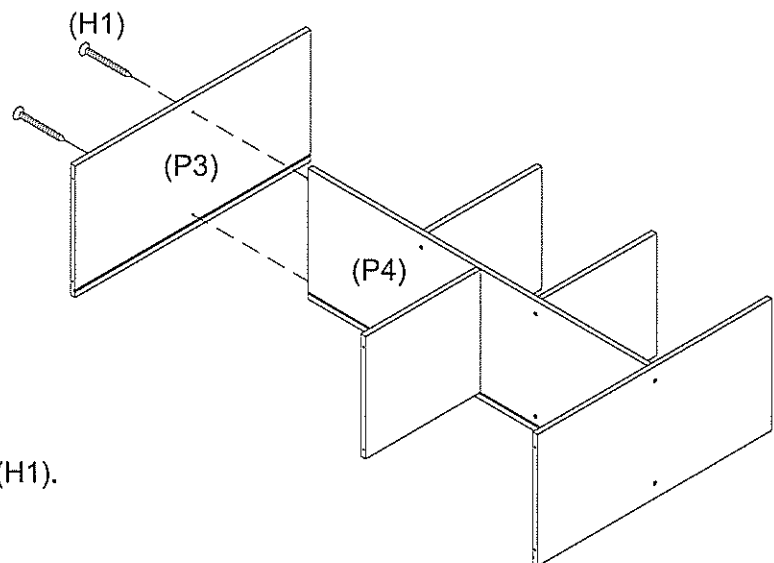

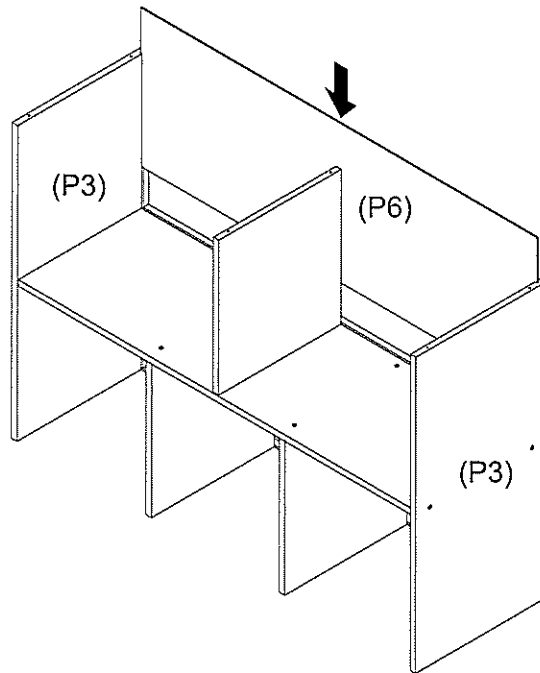

# Step 5

Slide Back Panel (P6) into place.



# Step 6

You will need	
	
6 x Long Screw (H1)	Phillips head screwdriver

Attach Side Panel (P1) using screws (H1).

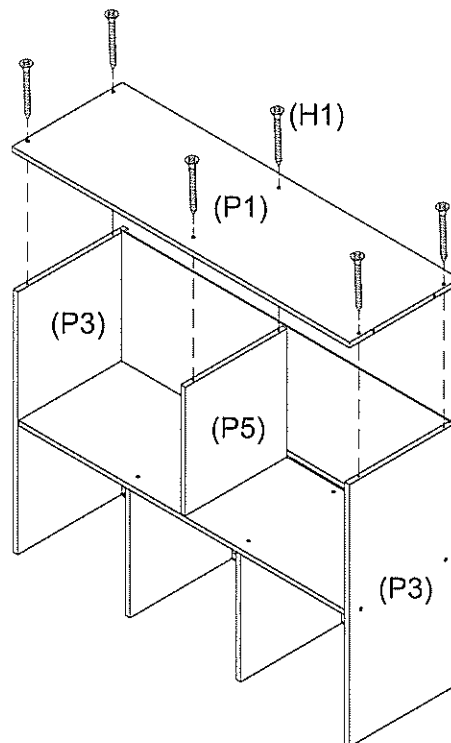

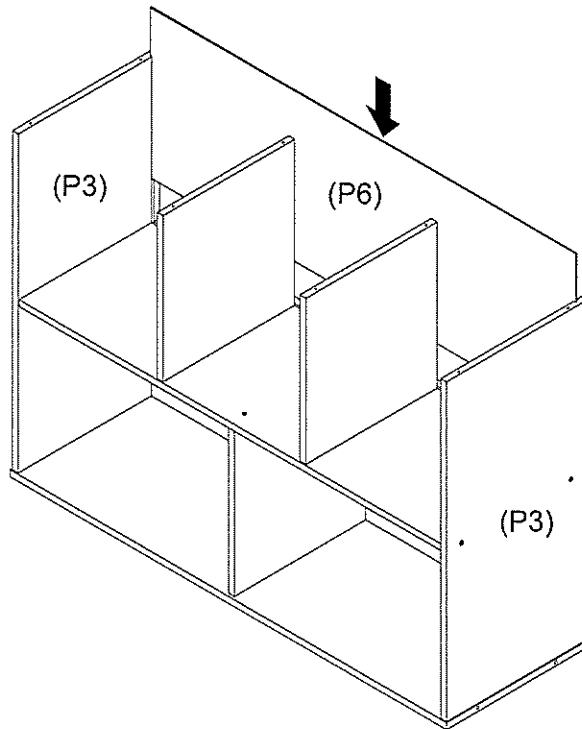

# Step 7

Slide Back Panel (P6) into place.



# Step 8

You will need	
	
8 x Long Screw (H1)	Phillips head screwdriver

Attach Side Panel (P2) using screws (H1).

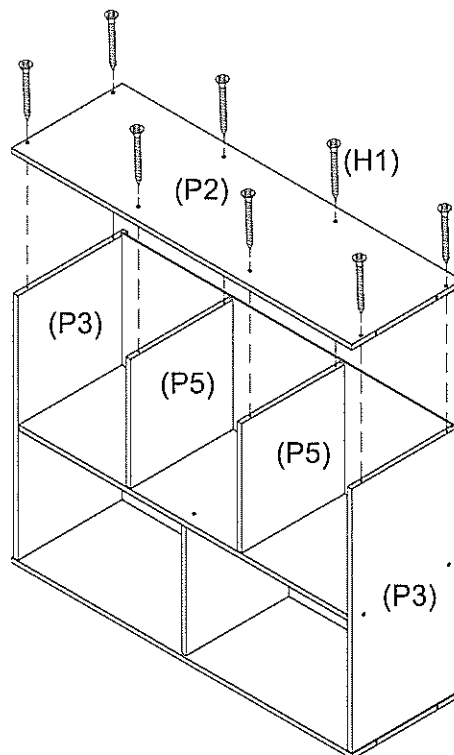



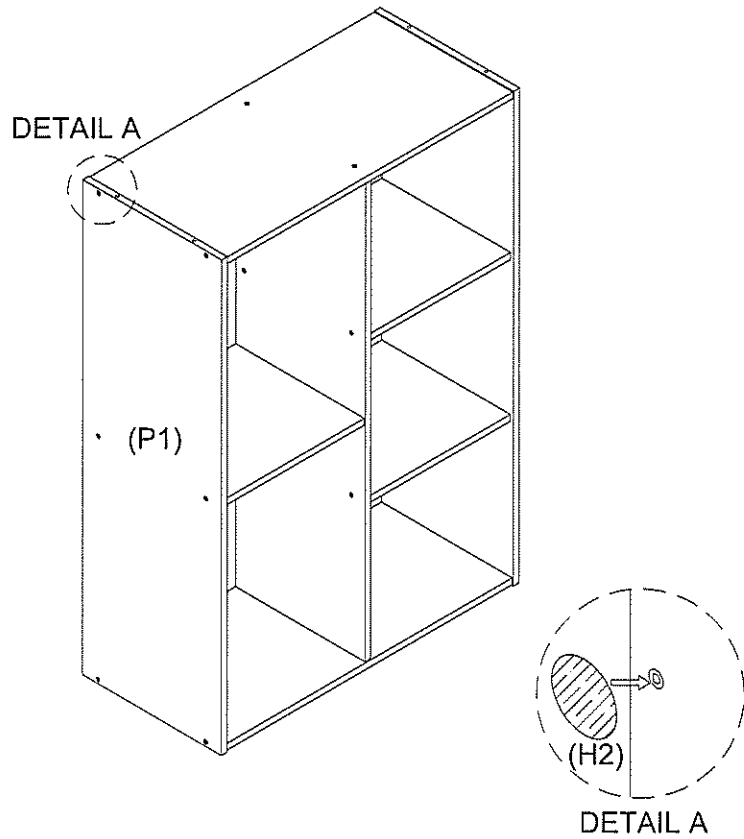

# Step 9

You will need	
	
24 x Sticker (H2)	

Place stickers to cover all screws as per Detail (A).



# Step 10

You will need	
	
1 x Pan Head Screw M3.5 x 12 (H6)	1 x Webbing (H5)
	
1 x Flat Washer (H7)	Phillips head screwdriver

Attach safety webbing to unit as per Detail (A).

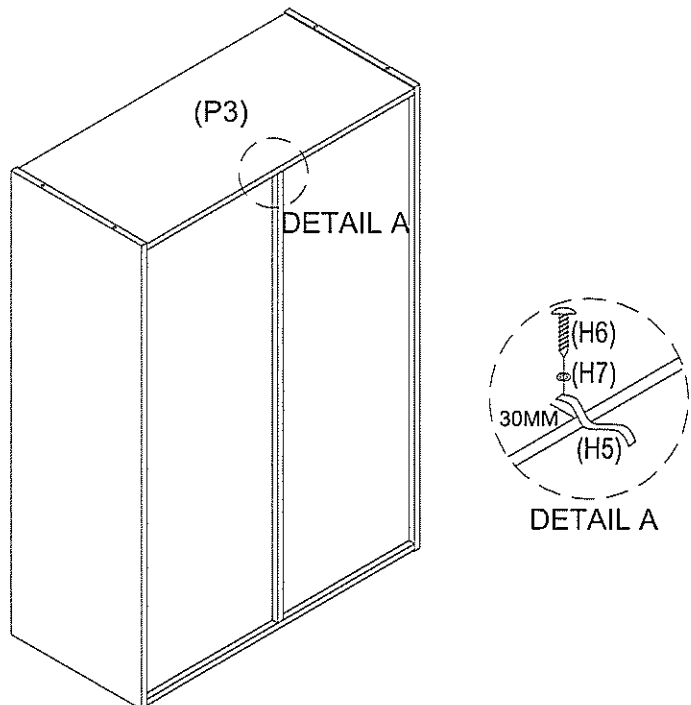



# Step 11

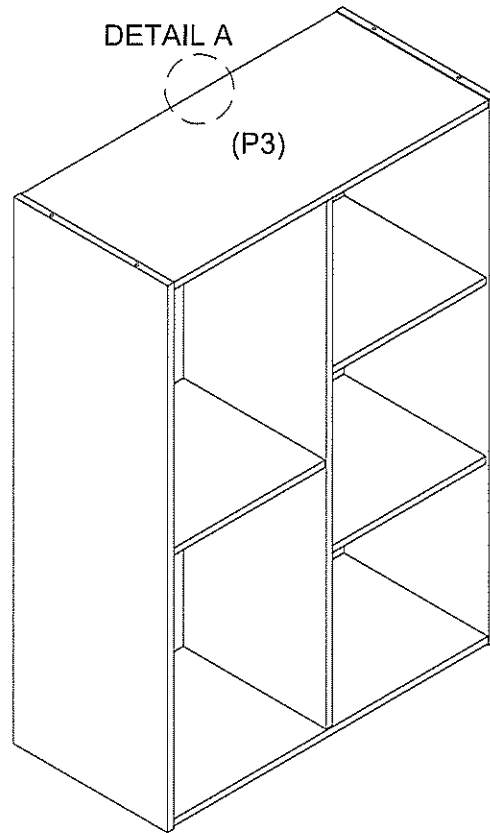
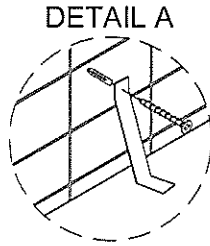



Screws and wall plugs are not provided please use appropriate fixtures for your wall.

Seek advice from a qualified trades person on how to attach this to your specific wall.

Move furniture to its final position, then connect the end of (H5) webbing to the wall. Make sure it is firmly attached and make sure it is snug fit.

# Step 12

You will need	
	
4 x Wood Dowel M6 x 25 (H3)	4 x Dowel Plug (H4)

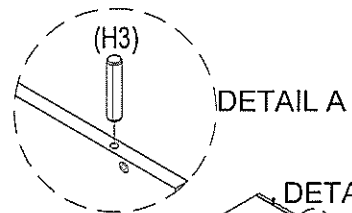
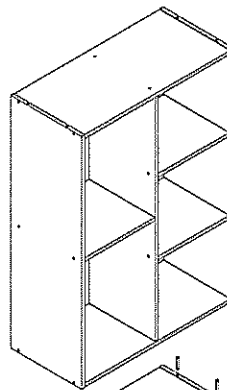
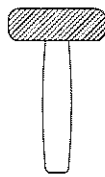

or

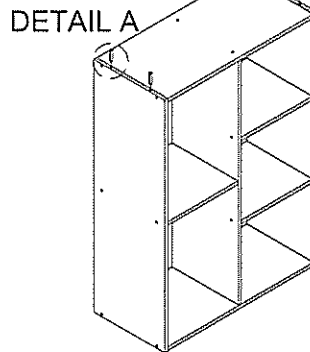
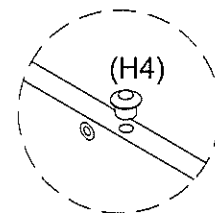
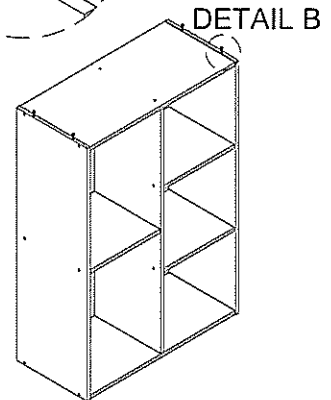

If you wish to stack insert wood dowels (H3) into panel (P3) and tap down with mallet as per detail (A). If you do not wish to stack, place dowel plug into panel (P3) as per detail (B).

# Step 13

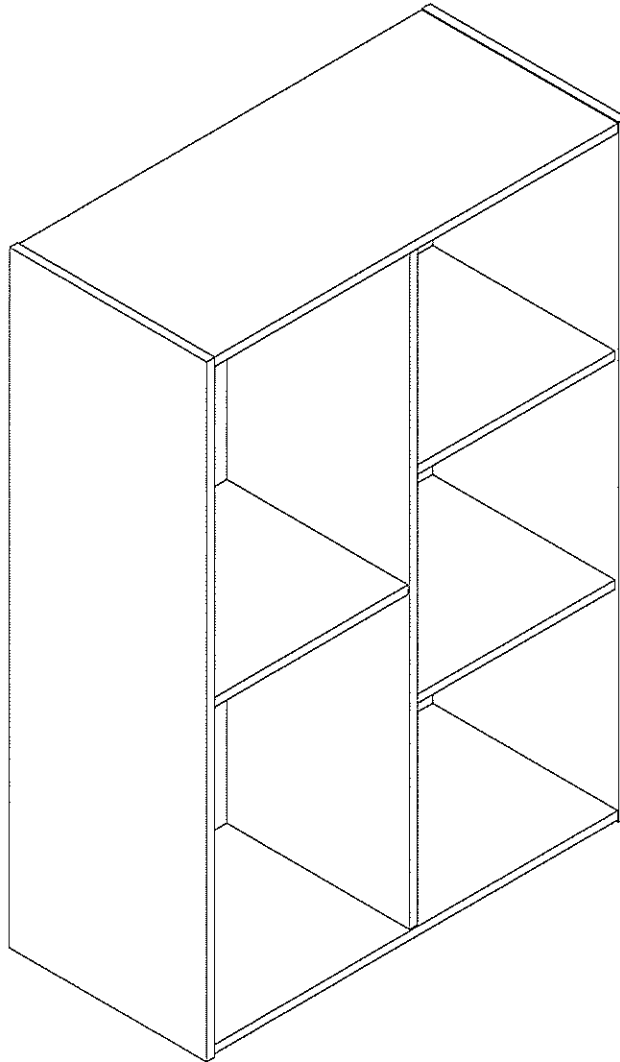

## Job Complete!

In the interest of our environment please dispose of all packaging thoughtfully.